



Rev 12/05/24

This page intentionally left blank

Table of Contents

Introduction	5
Warranty	5
Filter Bags	5
Operating Environment	5
Contact Information	6
Instrument Description.....	7
Instrument Installation	11
Fiber Analysis Support Items	13
Analysis Options using the ANKOM ^{DELTA} Automated Fiber Analyzer	13
ADF Analysis.....	14
NDF Analysis	20
Crude Fiber Analysis	26
Rinse Pump Feature.....	31
Periodic Maintenance	33
Troubleshooting & Replacement Parts.....	38
Appendix A - Analytical Procedures.....	39
Appendix B – Wiring Diagrams (1 of 6).....	44

This page intentionally left blank

Introduction

ANKOM Technology designs, manufactures, and markets instruments and support products used by analytical laboratories around the world in the environmental, agricultural, biomass, and food industries. ANKOM Technology can provide you with products for determining or monitoring detergent fibers, dietary fibers, fat, digestibility, microbial fermentation (anaerobic or aerobic) and more.

Committed to Total Customer Satisfaction, ANKOM designs every product based on a thorough assessment of customer needs.

Congratulations on your purchase of the ANKOM^{DELTA} Automated Fiber Analyzer. We are confident that this product will effectively serve your needs.

By carefully following the operating instructions in this manual, you will minimize errors in results. Experience indicates that errors in results are usually associated with minor variations in carrying out the procedure. This manual will provide you with details that will help assure accuracy of your results.

NOTE: Please review the entire contents of this manual before you begin operating this instrument.

Warranty

Unless otherwise stated or agreed upon, ANKOM Technology warrants the ANKOM^{DELTA} Automated Fiber Analyzer against any defects due to faulty workmanship or material for one year after the original date of purchase. This warranty does not include damage to the instrument resulting from neglect or misuse. During the warranty period, should any failure result from defects in workmanship or materials, ANKOM Technology will, at its discretion, repair or replace the instrument free of charge.

Extended warranties are available for purchase if desired.

Filter Bags

ANKOM Technology Filter Bags (part # F57 and F58) are designed to produce precision and accurate fiber results. The F57 bags should be used when grinding samples using a cutter type mill with a 1 mm screen which is typically referenced by the approved methods. For finer ground samples or if particle loss is suspected, use the F58 bags which have a finer pore size.

Use of other types of filtration media not tested and approved by ANKOM Technology may cause damage to electrical valves and other components and void your warranty. Filter bags can be purchased from ANKOM Technology or from your local authorized ANKOM distributor.

Operating Environment

Your ANKOM^{DELTA} Automated Fiber Analyzer is designed to operate within the following environments:

- Ambient Temperature Range: 15°–30°C
- Humidity: 20–60% RH
- Power (domestic): 110V–120V ~ 50/60Hz 15A
- Power (international): 220V–240V ~ 50/60Hz 10A

Contact Information

At ANKOM Technology we are committed to your total satisfaction and therefore always available to help you get the most from your ANKOM products. We are also very interested in any comments or suggestions you may have to help us improve.

For any questions or suggestions regarding your instrument, please contact us at:

For Sales Support: sales@ankom.com or <https://www.ankom.com/contact-us>

For Technical Support: www.ankom.com/contact/technical-services

For Analytical Support: www.ankom.com/contact/analytical-services

Telephone: (315) 986-8090

Fax: (315) 986-8091

Instrument Description

General Description

The ANKOM^{DELTA} Automated Fiber Analyzer is designed to efficiently and accurately determine Acid Detergent Fiber (ADF), Neutral Detergent Fiber (NDF), and Crude Fiber within food and/or feed samples. Enabled by Filter Bag Technology, up to 24 samples can be processed at one time.

During analysis cell contents are removed as the encapsulated sample is subjected to the appropriate chemical (AD, ND, or crude fiber acid and base) solutions, leaving the desired fiber fraction. Results are determined gravimetrically. The filter bags are designed to allow proper flow of solutions while retaining non-soluble components. The fiber residue captured in the filter bag can be used for follow-on assays such as ADIN, NDIN, and ADL.

Like the ANKOM²⁰⁰ and ANKOM²⁰⁰⁰ Fiber Analyzers, digestion and rinse operations are all performed within the same instrument, allowing for the elimination of the separate filtration step. Process temperatures are precisely controlled while providing proper agitation to ensure a uniform flow of chemical solutions and rinses across each sample. The ANKOM^{DELTA} Automated Fiber Analyzer contains a pump that automatically pulls the appropriate chemical into the instrument from a chemical container, i.e. cubitainer. No gravity feed is necessary.

Below are detailed views of the ANKOM^{DELTA} Automated Fiber Analyzer.

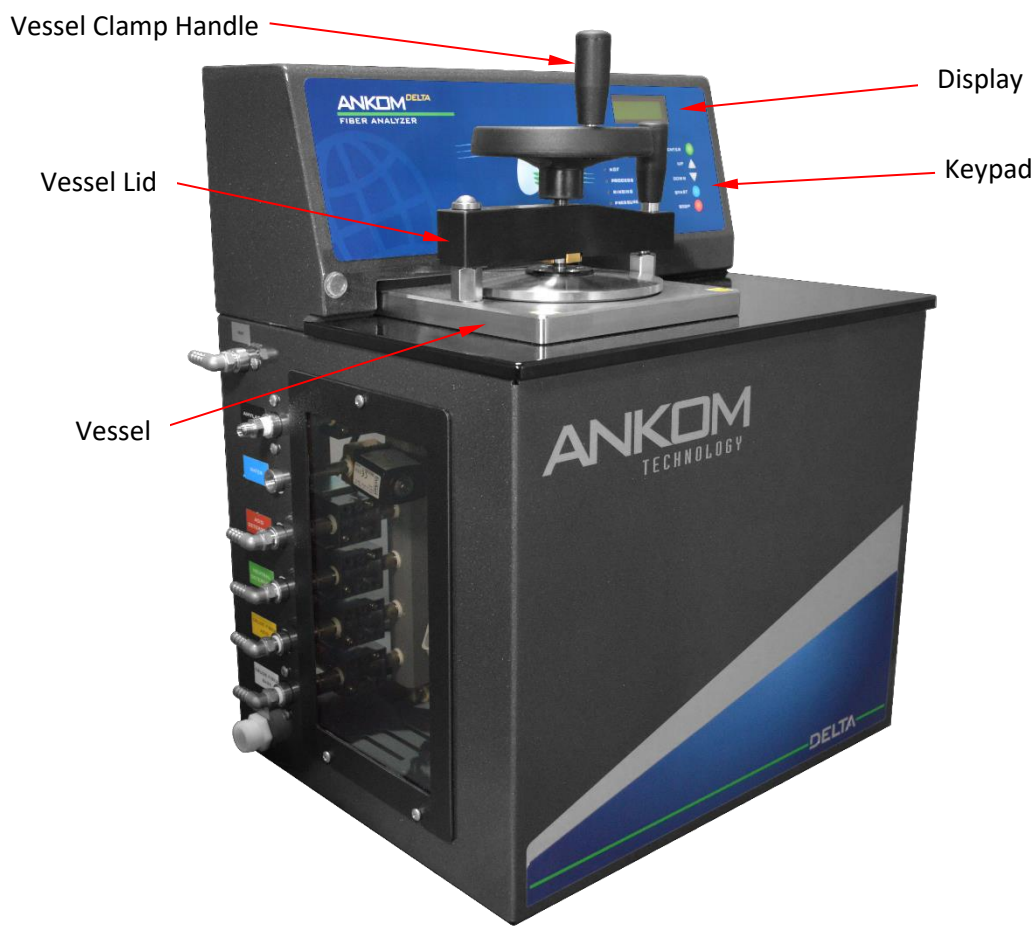

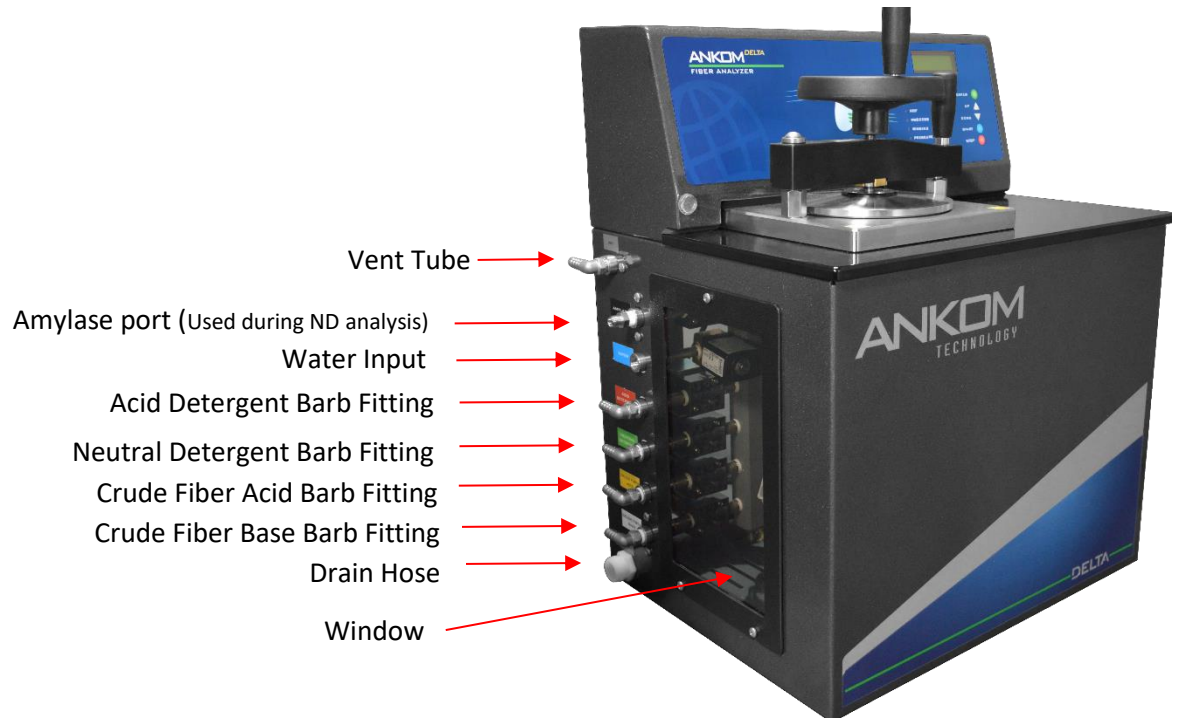

Left Side View

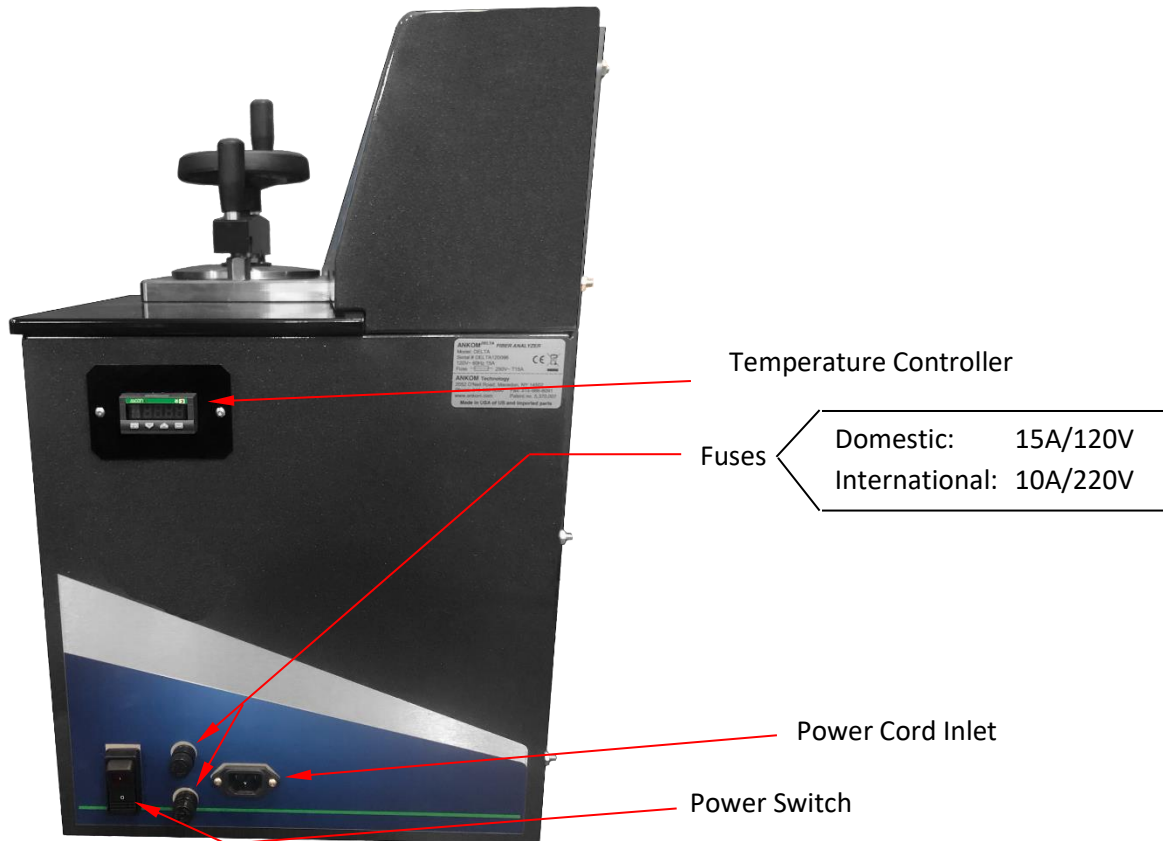

Right Side View

Internal Components

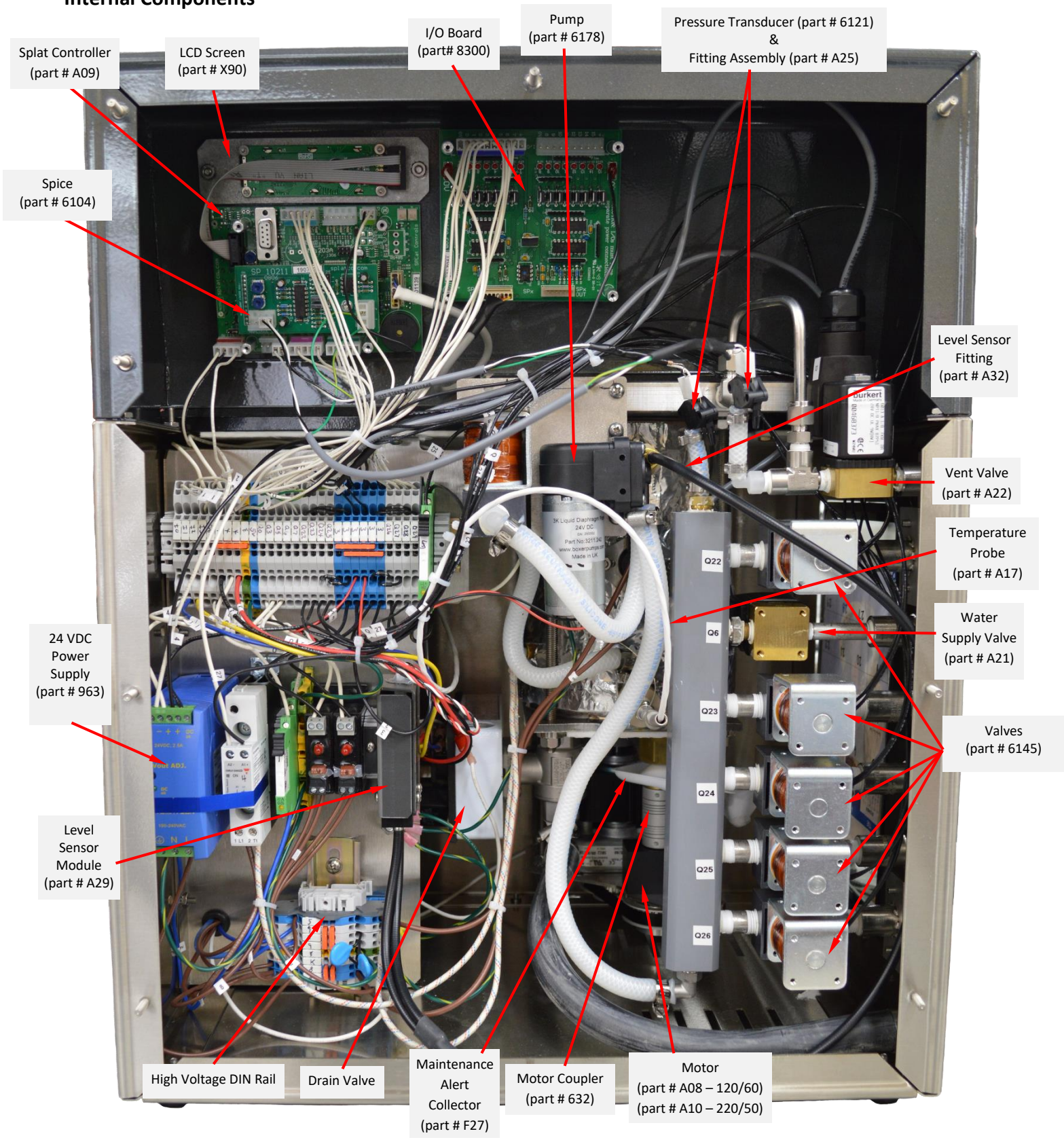

Safety Precautions / Description of Safety Stickers

- **On Vessel Top Surface**



Hazardous Pressure – Do NOT open the Vessel Lid during operation. The contents of the Vessel are hot and under pressure. **Failure to observe this caution may result in scalding or burning.**

- **On Side Access Cover**



Hot Surfaces, Hazardous Voltages and Rotating Parts – Do NOT operate the instrument with the Side Access Cover removed except for maintenance of the Packing Nut by trained personnel. **Failure to observe this caution may result in burning, electrical shock / electrocution or mechanical hazards.**

- **On Vessel Top Surface**



Hot Surfaces– Do NOT open the Vessel Lid during operation. The contents of the Vessel are hot and under pressure. **Failure to observe this caution may result in scalding or burns.**

- **On Rear Cover**



Hazardous Voltages– Do NOT operate the instrument with the back cover removed. Hazardous voltages are present during operation. The Power Cord must be disconnected prior to removal of the rear panel. **Failure to observe this caution may result in electrical shock or electrocution.**

Hazardous Materials – Follow SDS warnings and recommendations for all materials to be used in this instrument, caution should be used when handling hot effluent that may be caustic or corrosive. If necessary, the solution can be collected in a container and neutralized before disposal. Follow safe laboratory practices according to your local and federal regulations when installing and using this instrument and associated chemicals. **Failure to observe this caution may be hazardous to your health.**

WARNING: Attempts to override safety features or to use this instrument in a manner not specified by ANKOM Technology voids the warranty and may result in serious injury or even death.

This system is designed to meet and/or exceed the applicable standards of CE, CSA, and OSHA.

Instrument Installation

Site Requirements

To install and operate the ANKOM^{DELTA} Automated Fiber Analyzer you will need the following:

- Adjustable wrench
- Water supply is located within 6 feet (3 meters) of the ANKOM^{DELTA} and capable of heating water to 50°C for Crude Fiber and 70°C for ADF/NDF analysis. Note that the ANKOM^{DELTA} includes a Water Regulator that will reduce the pressure to 15psi. If your water supply pressure is too low you may receive a fault in which case refer to the **Rinse Pump Feature**
- Adequate power (see “Operating Environment” section)
- Drain
- Bench space that can accommodate the instrument dimensions of 56.64 cm (22.30”) L x 38.1 cm (15”) W x 58.42cm (23”) H and a weight of 33.57 kg (74 lbs.)

Instrument Installation Procedure

To install the ANKOM^{DELTA} Automated Fiber Analyzer, follow the procedure detailed below.

1. Remove the instrument from the shipping container and place it in an area that is within 6 feet of a drain and water supply on a surface that is firm and level. The instrument must not be subject to excessive shock, vibration, dirt, moisture, oil, or other fluids.

Your instrument comes complete with a Water Regulator Filter, Power Cord, an Outer Exhaust Hose Assembly, a Vent Tube, a Bag Suspender Assembly (including Bag Suspender Trays and a Bag Suspender Weight), an Amylase Container, and, unless otherwise agreed upon, four standard six foot chemical tubes for the acid detergent, neutral detergent, crude fiber acid and crude fiber base barb fittings.



Water Regulator
Assembly
Part #: DELTA18



Power Cord	Outer Exhaust Hose Assembly Part #: F12	Bag Suspender W/ Weight Part #: F11
---------------	---	---



Amylase Dispenser
Assembly
Part #: DELTA03



Chemical Tubes

2. With the Power Switch in the OFF position, plug the Power Cord into the Power Cord Inlet on the instrument.
3. Plug the Power Cord into the power source.
4. Install the Water Regulator Filter into the labeled water input. Attach ¼" copper tubing to the hot water source and the other end to the Water Regulator Filter. (Water supply must be at least 50°C for Crude Fiber, or 70°C for ND and AD. Optional water heater available, part# A02.)
5. Connect and secure the Drain Hose so that it will not move when hot pressurized fluid is exhausted.
6. Connect the four chemical tubes to their labeled barb fitting. Place the other end securely in your chemical container. Chemical containers may be placed anywhere within six to ten feet of the instrument. An optional bulk chemical delivery system is available. The system will pump the chemical into the instrument; it is not gravity fed.
7. Attach the Vent Tube to the labeled barb fitting. Place the other end of the Vent Tube where it can safely vent or drain if necessary, without being submerged.



Fiber Analysis Support Items

The following support items are needed to perform the fiber analysis procedures:

Item	Recommended Product
Filter Bags	ANKOM #F57, #F58
Bag Holder (used for adding sample to an empty filter bag)	ANKOM #X20
Heat Sealer for sealing the filter bags	ANKOM #HS (120V), #HSi (220V)
Solvent Resistant Marker	ANKOM #F08
Desiccant Pouch	ANKOM #X45
Oven for drying (capable of maintaining 102°C ± 2°)	ANKOM #RD (120V), #RDI (220V)
Sample	
Spoon	
Hot Water Heater	ANKOM A02
Water Filter Regulator Assembly	
Acid Detergent	ANKOM FAD20CB cubitainer ANKOM FAD20 Concentrate ANKOM FAD20C, Concentrate-dry CTAB powder
Neutral Detergent	ANKOM FND20 cubitainer ANKOM FND20C Dry Concentrate
Crude Fiber Acid	ANKOM FCFA20CB cubitainer ANKOM FCFA20 Concentrate
Crude Fiber Base	ANKOM FCFB20CB cubitainer ANKOM FCFB20 Concentrate
Alpha Amylase	ANKOM FAA

Analysis Options using the ANKOM^{DELTA} Automated Fiber Analyzer

The ANKOM^{DELTA} Automated Fiber Analyzer can be configured to run ADF, NDF, and Crude Fiber analyses. The instrument will run with default digestion and rinse time settings unless you select the Custom analysis option. This option allows you to do ADF, NDF, or Crude Fiber analyses using custom digestion and rinse time settings.

For maintenance purposes, the ANKOM^{DELTA} also flushes the chemical lines and valves after each run automatically.

The following sections provide the information you will need to use and maintain the ANKOM^{DELTA} Automated Fiber Analyzer.

ADF Analysis

ADF Calculation

ADF contained within a food or feed sample can be calculated using the following formula:

% ADF (as-received basis)	=	$\frac{100 \times (W_3 - (W_1 \times C_1))}{W_2}$
Where:		
	W_1	= Bag tare weight
	W_2	= Sample weight
	W_3	= Dried weight of filter bag with fiber after extraction process
	C_1	= Blank bag correction (running average of final oven-dried weight divided by original blank bag weight)

ADF Sample Preparation Procedure

To prepare samples for fiber analysis, follow the procedure detailed below.

IMPORTANT:

When using the ANKOM^{DELTA} Automated Fiber Analyzer for ADF analysis, at least one blank filter bag should be included with the sample set as an indicator of particle loss. A running average of the blank bag weights is used in the fiber calculation as the C_1 correction factor. A C_1 value larger than 1.0000 indicates that sample particles were lost from filter bags and deposited on the blank bag. Any fiber particle loss from the filter bags will generate erroneous results. If particle loss is observed, the grinding method for the specific sample should be evaluated.

- Using a Solvent Resistant Marker, number all of the filter bags you will use during the fiber analysis. Allow the marker to dry on the filter bags.
- Weigh and record the weight of each empty filter bag (W_1).
- Set the Heat Sealer dial to between 4 and 5. (The setting may vary from sealer to sealer.)
- Seal at least one empty filter bag (to be used as a blank) within 4mm of its open end. Keep the sealer arm down for 2 – 3 seconds after the red sealer light turns off (to cool the seal). The seal can be seen as a solid melted stripe along the top edge of the filter bag (as shown to the right). If the seal is not strong, re-seal the bag.
- Place an empty filter bag in the Bag Weigh Holder in an open position.
- Tare the weight of the empty filter bag and the holder together.
- Add 0.45 – 0.50g of sample to the filter bag. Keep all particles away from the sealing area of the filter bag.
- Record the weight of the sample (W_2).

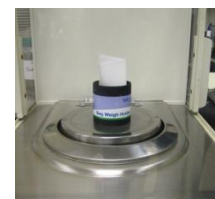

9. Seal the filter bag within 4mm of its open end. Keep the sealer arm down for 2 – 3 seconds after the red sealer light turns off (to cool the seal). The seal can be seen as a solid melted stripe along the top edge of the filter bag. If the seal is not strong, re-seal the bag.
10. Spread the sample out uniformly within the filter bag by shaking and flicking the bag to eliminate clumping.
11. Repeat steps 5 – 10 for all filter bags that will be used in the Analyzer. (Up to 24 bags can be processed during one procedure.)
12. Follow these pre-extraction steps for specified samples.

12.1 If your samples contain non-roasted soybean or >5% fat:

Before doing the ADF analysis in the ANKOM^{DELTA}, you will need to do a pre-extraction. For samples containing non-roasted soybean or >5% fat, follow the pre-extraction steps below:

- 12.1.1 Place the filter bags with sample (up to 23) into a container with a top.
- 12.1.2 Pour enough fresh acetone into the container to cover the bags.
- 12.1.3 Put the top on the container.
- 12.1.4 Allow bags to soak for 10 minutes.
- 12.1.5 Pour out and dispose of the acetone.
- 12.1.6 Execute steps 1 through 5 a total of two times.
- 12.1.7 Place the bags on a wire screen to air-dry.

12.2 If your samples contain roasted soybean:

Before doing the ADF analysis in the ANKOM^{DELTA}, you will need to do a pre-extraction. For samples containing roasted soybean, follow the pre-extraction steps below:

- 12.2.1 Place the filter bags with sample (up to 23) into a container with a top.
- 12.2.2 Pour enough fresh acetone into the container to cover the bags.
- 12.2.3 Put the top on the container.
- 12.2.4 Shake the container 10 times.
- 12.2.5 Allow the samples to soak for twelve hours.
- 12.2.6 Pour out the acetone
- 12.2.7 Place the bags on a wire screen to air-dry.

13. If the sample has settled to the bottom of the bag, spread the sample uniformly inside the filter bags by shaking and flicking the bags to eliminate clumping.
14. Place the filter bags with sample and at least one empty bag (used as a blank) into the Bag Suspender trays as shown (maximum of three bags per tray).
15. Stack each tray on the Bag Suspender rod (eight trays in total) with each tray rotated 120 degrees from the tray below.

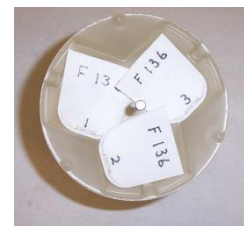

IMPORTANT: You must use all eight trays even if they are empty.

16. Add the 9th tray to the top of the Bag Suspender rod. This tray contains no filter bags and acts as a cover.

NOTE: The samples are now ready for the ADF analysis procedure.

ADF Analysis Procedure using the ANKOM^{DELTA} Automated Fiber Analyzer

NOTE: If you are following the acid detergent procedure with an acid detergent lignin, you can find the lignin procedure on our website at www.ankom.com.

To perform ADF analysis on prepared samples, follow the procedure detailed below.

NOTE: The instrument automatically flushes the chemical lines and valves after each run.

1. Verify that the hot water supply is on and the drain hose is securely positioned in the drain.
2. Ensure the AD chemical tube is securely connected to the acid detergent valve and to your AD solution container (cubitainer, tank, etc.)

NOTE: The chemicals are pumped into the instrument via the pump and valves.

3. Open the Vessel Lid.
4. Place the Bag Suspender with the samples into the Vessel.
5. Place the Bag Suspender Weight onto the Bag Suspender rod to hold the trays in place.



- Turn the instrument Power Switch to the ON position. The Display will light and allow you to select an analysis procedure.

- Press the arrow keys on the Keypad until you see "Select ADF" on the Display.

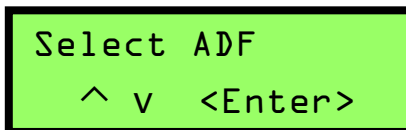

IMPORTANT: The ADF analysis will use the following default settings:

- 60 minute digestion
- four 5 minute rinses

- Press ENTER on the Keypad and follow the prompts on the Display to set up the instrument for ADF analysis.
- Close the Vessel Lid and tighten it by turning the Vessel Clamp Handle.



NOTE:

There are many ways you can supply solutions to your instrument. The flexible chemical tubes that attach to each valve allow you to pull solution from any type of chemical container: cubitainer, large chemical tanks, etc.

- Press START on the Keypad. Solution will flow into the vessel through the acid detergent chemical tube and valve.

NOTE:

Once the analysis begins, digestions and rinses occur automatically, with the analyzer Display providing information about the process time remaining, the temperature, and the pressure. Pressing STOP on the Keypad at any time during the analysis ends the operation and opens the drain to exhaust the solution.

- When the "Extraction Done" message appears on the Display, the analyzer operation is complete. Open the Vessel Lid, remove the bags and place them in an appropriately sized beaker.
- With your hands, gently press out excess water from the bags into the beaker and pour off the water from the beaker.
- With the bags in the beaker, add enough acetone to cover them. Let the bags soak in acetone for 3 – 5 minutes. Then pour off the acetone.
- With your hands, gently press out excess acetone from the bags into the beaker and pour off the acetone from the beaker.
- Remove the bags from the beaker and place them on a wire screen to air-dry.



Hazardous Materials – Do NOT place bags in an oven until all acetone has evaporated.

- Place air-dried bags in the oven and heat at 102°C ± 2° for 2 – 4 hours (depending on the oven).

IMPORTANT:

When running a lignin procedure or a sequential (NDF/ADF or NDF/ADF/Lignin) with F57 Filter Bags it is important not to dry the bags overnight after the NDF or ADF procedure. A drying timeframe of 2-4 hours at 100°C to 105°C is sufficient to thoroughly dry the bags after each procedure. Extended drying times or too high a temperature can compromise the bag's filtration media. In addition, after the fourth rinse during the ADF procedure if you would like to confirm the acid has been completely rinsed from the bags, capture some water from the waste tube and check the water with litmus paper.

17. Remove the bags from the oven and place them in a Desiccant Pouch.

**IMPORTANT:**

Do NOT use conventional countertop or cabinet desiccators for this analysis.

18. Allow the bags to cool to room temperature. This should take about 10 – 15 minutes.
19. Remove one filter bag from the Desiccant Pouch. Press the pouch to remove ambient air and zip it tight.
20. Re-weigh the filter bag (W_3) immediately.
21. Repeat steps 19 and 20 for each filter bag in the Desiccant Pouch.
22. Calculate ADF using the following formula.

% ADF (as-received basis)	=	$\frac{100 \times (W_3 - (W_1 \times C_1))}{W_2}$
Where:	W_1	= Bag tare weight
	W_2	= Sample weight
	W_3	= Dried weight of filter bag with fiber after extraction process
	C_1	= Blank bag correction (running average of final oven-dried weight divided by original blank bag weight)

NOTE:

If you are following the acid detergent procedure with an acid detergent lignin, you can find the lignin procedure on our website at www.ankom.com.

This page intentionally left blank

NDF Analysis

NDF Calculation

NDF contained within a food or feed sample can be calculated using the following formula:

$$\% \text{ NDF (as-received basis)} = \frac{100 \times (W_3 - (W_1 \times C_1))}{W_2}$$

Where:

- W_1 = Bag tare weight
- W_2 = Sample weight
- W_3 = Dried weight of filter bag with fiber after extraction process
- C_1 = Blank bag correction (running average of final oven-dried weight divided by original blank bag weight)

NDF Sample Preparation Procedure

To prepare samples for fiber analysis, follow the procedure detailed below.

IMPORTANT:

When using the ANKOM^{DELTA} Automated Fiber Analyzer for NDF analysis, at least one blank filter bag should be included with the sample set as an indicator of particle loss. A running average of the blank bag weights is used in the fiber calculation as the C_1 correction factor. A C_1 value larger than 1.0000 indicates that sample particles were lost from filter bags and deposited on the blank bag. Any fiber particle loss from the filter bags will generate erroneous results. If particle loss is observed, the grinding method for the specific sample should be evaluated.

- Using a Solvent Resistant Marker, number all of the filter bags you will use during the fiber analysis. Allow the marker to dry on the filter bags.



- Weigh and record the weight of each empty filter bag (W_1).

- Set the Heat Sealer dial to between 4 and 5. (The setting may vary from sealer to sealer.)



Seal

- Seal at least one empty filter bag (to be used as a blank) within 4mm of its open end. Keep the sealer arm down for 2 – 3 seconds after the red sealer light turns off (to cool the seal). The seal can be seen as a solid melted stripe along the top edge of the filter bag (as shown to the right). If the seal is not strong, re-seal the bag.



- Place an empty filter bag in the Bag Weigh Holder in an open position.

- Tare the weight of the empty filter bag and the holder together.
- Add 0.45 – 0.50g of sample to the filter bag. Keep all particles away from the sealing area of the filter bag.
- Record the weight of the sample (W_2).

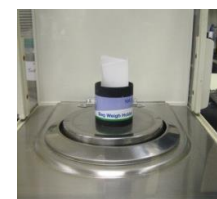

- Seal the filter bag within 4mm of its open end. Keep the sealer arm down for 2 – 3 seconds after the red

sealer light turns off (to cool the seal). The seal can be seen as a solid melted stripe along the top edge of the filter bag. If the seal is not strong, re-seal the bag.

10. Spread the sample out uniformly within the filter bag by shaking and flicking the bag to eliminate clumping.
11. Repeat steps 5 – 10 for all filter bags that will be used in the Analyzer. (Up to 24 bags can be processed during one procedure.)
12. Follow these pre-extraction steps for specified samples.

12.1 If your samples contain non-roasted soybean or >5% fat:

Before doing the NDF analysis in the ANKOM^{DELTA}, you will need to do a pre-extraction. For samples containing non-roasted soybean or >5% fat, follow the pre-extraction steps below:

- 12.1.1 Place the filter bags with sample (up to 23) into a container with a top.
- 12.1.2 Pour enough fresh acetone into the container to cover the bags.
- 12.1.3 Put the top on the container.
- 12.1.4 Allow bags to soak for 10 minutes.
- 12.1.5 Pour out and dispose of the acetone.
- 12.1.6 Execute steps 1 through 5 a total of two times.
- 12.1.7 Place the bags on a wire screen to air-dry.

12.2 If your samples contain roasted soybean:

Before doing the NDF analysis in the ANKOM^{DELTA}, you will need to do a pre-extraction. For samples containing roasted soybean, follow the pre-extraction steps below:

- 12.2.1 Place the filter bags with sample (up to 23) into a container with a top.
- 12.2.2 Put the top on the container.
- 12.2.3 Shake the container 10 times.
- 12.2.4 Allow the samples to soak for twelve hours.
- 12.2.5 Pour out the acetone

Place the bags on a wire screen to air-dry.

13. If the sample has settled to the bottom of the bag, spread the sample uniformly inside the filter bags by shaking and flicking the bags to eliminate clumping.
14. Place the filter bags with sample and at least one empty bag (used as a blank) into the Bag Suspender trays as shown (maximum of three bags per tray).
15. Stack each tray on the Bag Suspender rod (eight trays in total) with each tray rotated 120 degrees from the tray below.

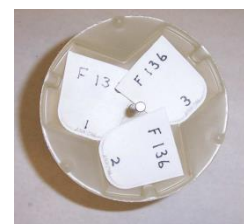

IMPORTANT: You must use all eight trays even if they are empty.

16. Add the 9th tray to the top of the Bag Suspender rod. This tray contains no filter bags and acts as a cover.

NOTE: The samples are now ready for the NDF analysis procedure.

NDF Analysis Procedure using the ANKOM^{DELTA} Automated Fiber Analyzer

To perform NDF analysis on prepared samples, follow the procedure detailed below.

NOTE: The instrument automatically flushes the chemical lines and valves after each run.

1. Verify that the hot water supply is on and the drain hose is securely positioned in the drain.
2. Ensure the ND chemical tube is securely connected to the neutral detergent valve and to your ND solution container (cubitainer, tank, etc.)

NOTE: The chemicals are pumped into the instrument via the pump and valves.

3. Open the Vessel Lid.



4. Place the Bag Suspender with the samples into the Vessel.



5. Place the Bag Suspender Weight onto the Bag Suspender rod to hold the trays in place.



6. Attach the DELTA Amylase Container Assembly to the valve labeled Amylase. This will be used to automatically add amylase to the vessel during the rinses.
7. Add water until the dispenser is 25% full.
8. Add two capfuls (8ml) of amylase to the dispenser.
9. Add water until the dispenser is 75% full.



10. Turn the instrument Power Switch to the ON position. The Display will light and allow you to select an analysis procedure.
11. Press the arrow keys on the Keypad until you see "Select NDF" on the Display.

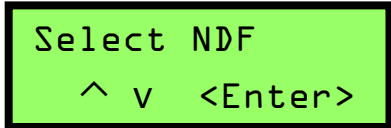

IMPORTANT: The NDF analysis will use the following default settings:

- 75 minute digestion
- four 5 minute rinses

12. Press ENTER on the Keypad and follow the prompts on the Display to set up the instrument for NDF analysis.

NOTE: There are many ways you can supply solutions to your instrument. The flexible chemical tubes that attach to each valve allow you to pull solution from any type of chemical container: cubitainer, large chemical tanks, etc.

13. Press START on the Keypad. Solution from the chemical container will flow into the vessel through the neutral detergent valve.

NOTE: Once the analysis begins, digestions and rinses occur automatically, with the analyzer Display providing information about the process time remaining, the temperature, and the pressure. Pressing STOP on the Keypad at any time during the analysis ends the operation and opens the drain to exhaust the solution.

14. After the ND solution has been added and agitation begins, manually add 20g of Na₂SO₃ and 4.0ml of alpha-amylase directly into the Vessel.
15. Close the Vessel Lid and tighten it by turning the Vessel Clamp Handle.



16. When the "Extraction Done" message appears on the Display, the analyzer operation is complete. Open the Vessel Lid, remove the bags and place them in an appropriately sized beaker.

17. With your hands, gently press out excess water from the bags into the beaker and pour off the water from the beaker.
18. With the bags in the beaker, add enough acetone to cover them. Let the bags soak in acetone for 3 – 5 minutes. Then pour off the acetone.
19. With your hands, gently press out excess acetone from the bags into the beaker and pour off the acetone from the beaker.
20. Remove the bags from the beaker and place them on a wire screen to air-dry.



Hazardous Materials – Do NOT place bags in an oven until all acetone has evaporated.

21. Place air-dried bags in the oven and heat at 102°C ± 2° for 2 – 4 hours (depending on the oven).

IMPORTANT:

When running a lignin procedure or a sequential (NDF/ADF or NDF/ADF/Lignin) with F57 Filter Bags it is important not to dry the bags overnight after the NDF or ADF procedure. A drying timeframe of 2-4 hours at 100°C to 105°C is sufficient to thoroughly dry the bags after each procedure. Extended drying times or too high a temperature can compromise the bag's filtration media. In addition, after the fourth rinse during the ADF procedure if you would like to confirm the acid has been completely rinsed from the bags, capture some water from the waste tube and check the water with litmus paper.

22. Remove the bags from the oven and place them in a Desiccant Pouch.

IMPORTANT:

Do NOT use conventional countertop or cabinet desiccators for this analysis.



23. Allow the bags to cool to room temperature. This should take about 10 – 15 minutes.
24. Remove one filter bag from the Desiccant Pouch. Press the pouch to remove ambient air and zip it tight.
25. Re-weigh the filter bag (W₃) immediately.
26. Repeat steps 24 and 25 for each filter bag in the Desiccant Pouch.
27. Calculate NDF using the following formula.

$$\% \text{ NDF (as-received basis)} = \frac{100 \times (W_3 - (W_1 \times C_1))}{W_2}$$

Where:

- W₁ = Bag tare weight
- W₂ = Sample weight
- W₃ = Dried weight of filter bag with fiber after extraction process
- C₁ = Blank bag correction (running average of final oven-dried weight divided by original blank bag weight)

This page intentionally left blank

Crude Fiber Analysis

Crude Fiber Calculation

Crude Fiber contained within a food or feed sample can be calculated using the following formula:

% Crude Fiber	=	$\frac{100 \times (W_3 - (W_1 \times C_1))}{W_2}$
Where:	W ₁	= Bag tare weight
	W ₂	= Sample weight
	W ₃	= Weight of Organic Matter (loss of weight on ignition of bag and fiber)
	C ₁	= Ash corrected blank bag factor (running average of loss of weight on ignition of blank bag / original blank bag)

Crude Fiber Sample Preparation Procedure

To prepare samples for fiber analysis, follow the procedure detailed below.

IMPORTANT:

When using the ANKOM^{DELTA} Automated Fiber Analyzer for Crude Fiber analysis, at least one blank filter bag should be included with the sample set as an indicator of particle loss. A running average of the blank bag weights is used in the fiber calculation as the C₁ correction factor. A C₁ value larger than 1.0000 indicates that sample particles were lost from filter bags and deposited on the blank bag. Any fiber particle loss from the filter bags will generate erroneous results. If particle loss is observed, the grinding method for the specific sample should be evaluated.

- Using a Solvent Resistant Marker, number all of the filter bags you will use during the fiber analysis. Allow the marker to dry on the filter bags.
- Weigh and record the weight of each empty filter bag (W₁).
- Set the Heat Sealer dial to between 4 and 5. (The setting may vary from sealer to sealer.)
- Seal at least one empty filter bag (to be used as a blank) within 4mm of its open end. Keep the sealer arm down for 2 – 3 seconds after the red sealer light turns off (to cool the seal). The seal can be seen as a solid melted stripe along the top edge of the filter bag (as shown to the right). If the seal is not strong, re-seal the bag.
- Place an empty filter bag in the Bag Weigh Holder in an open position.
- Tare the weight of the empty filter bag and the holder together.
- Add 0.95 – 1.00g of sample to the filter bag. Keep all particles away from the sealing area of the filter bag.
- Record the weight of the sample (W₂).
- Seal the filter bag within 4mm of its open end. Keep the sealer arm down for 2 – 3 seconds after the red

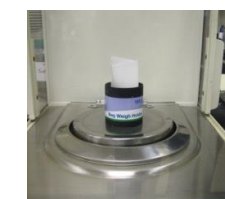
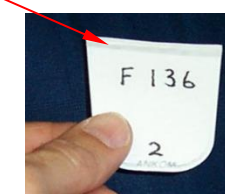

sealer light turns off (to cool the seal). The seal can be seen as a solid melted stripe along the top edge of the filter bag. If the seal is not strong, re-seal the bag.

10. Spread the sample out uniformly within the filter bag by shaking and flicking the bag to eliminate clumping.
11. Repeat steps 5 – 10 for all filter bags that will be used in the Analyzer. (Up to 24 bags can be processed during one procedure.)

12. For all samples you will need to do a pre-extraction of fat.

Before doing a Crude Fiber analysis in the ANKOM^{DELTA}, follow the pre-extraction steps below:

- 12.1 Place the filter bags with sample into an appropriately sized container.
- 12.2 Pour enough petroleum ether into the container to cover the bags.
- 12.3 Put the top on the container.
- 12.4 Allow the bags to soak for 10 minutes.
- 12.5 Pour out and dispose of the petroleum ether.
- 12.6 Place the bags on a wire screen to air-dry.

13. If the sample has settled to the bottom of the bag, spread the sample uniformly inside the filter bags by shaking and flicking the bags to eliminate clumping.
14. Place the filter bags with sample and at least one empty bag (used as a blank) into the Bag Suspender trays as shown (maximum of three bags per tray).
15. Stack each tray on the Bag Suspender rod (eight trays in total) with each tray rotated 120 degrees from the tray below.

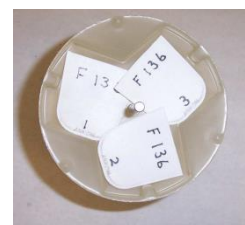

IMPORTANT: You must use all eight trays even if they are empty.

16. Add the 9th tray to the top of the Bag Suspender rod. This tray contains no filter bags and acts as a cover.

NOTE: The samples are now ready for the Crude Fiber analysis procedure.

Crude Fiber Analysis Procedure using the ANKOM^{DELTA} Automated Fiber Analyzer

To perform Crude Fiber analysis on prepared samples, follow the procedure detailed below.

NOTE: The instrument automatically flushes the chemical lines and valves after each run.

1. Verify that the hot water supply is on and the drain hose is securely positioned in the drain.
2. Attach the crude fiber acid and crude fiber base tubes to their appropriate chemical containers (Cubitainer, chemical tank, etc.)

NOTE: The chemicals are pumped into the instrument via the pump and valves.

3. Open the Vessel Lid.



4. Place the Bag Suspender with the samples into the Vessel.

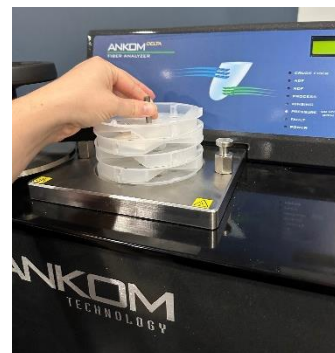

5. Place the Bag Suspender Weight onto the Bag Suspender rod to hold the trays in place.



6. Turn the instrument's Power Switch to the ON position. The Display will light and allow you to select an analysis procedure.

- Press the arrow keys on the Keypad until you see "Select Crude Fib" on the Display.

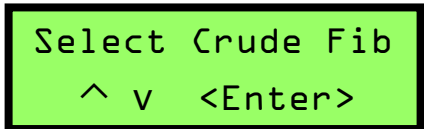

IMPORTANT: The Crude Fiber analysis will use the following default settings:

- 40 minute Acid digestion
- 40 minute Base digestion
- two 5 minute Acid rinses
- three 5 minute Base rinses

If you want to run a custom Crude Fiber analysis that allows you to set the digestion times and the number of rinse cycles, press the arrow keys until you see "Select Custom" on the Display.

- Press ENTER on the Keypad and follow the prompts on the Display to set up the instrument for Crude Fiber analysis.
- Close the Vessel Lid tightening it by turning the Vessel Clamp Handle.



- Press START on the Keypad. Solution will flow first into the vessel through the crude fiber acid valve.

NOTE: Once the analysis begins, digestions and rinses occur automatically, with the analyzer Display providing information about the process time remaining, the temperature, and the pressure. Pressing STOP on the Keypad at any time during the analysis ends the operation and opens the drain to exhaust the solution.

- When the "Extraction Done" message appears on the Display, the analyzer operation is complete. Open the Vessel Lid, remove the bags and place them in an appropriately sized beaker.
- With your hands, gently press out excess water from the bags into the beaker and pour off the water from the beaker.
- With the bags in the beaker, add enough acetone to cover them. Let the bags soak in acetone for 3 – 5 minutes. Then pour off the acetone.
- With your hands, gently press out excess acetone from the bags into the beaker and pour off the acetone from the beaker.
- Remove the bags from the beaker and place them on a wire screen to air-dry.



 **Hazardous Materials** – Do NOT place bags in an oven until all acetone has evaporated.

- Place air-dried bags in the oven and heat at 102°C ± 2° for 2 – 4 hours (depending on the oven).
- Remove the bags from the oven and place them in a Desiccant Pouch.

IMPORTANT: Do NOT use conventional countertop or cabinet desiccators for this analysis.



18. Allow the bags to cool to room temperature. This should take about 10 – 15 minutes.
19. Re-weigh each filter bag immediately after removing from the Desiccant Pouch.
20. Ash all filter bags in pre-weighed crucibles for 2 hours at 600°C ± 15°.
21. Cool the ashed crucibles in a conventional desiccator.
22. Weigh the ashed crucibles to calculate the loss of weight of organic matter (W₃).
23. Calculate Crude Fiber using the following formula.

% Crude Fiber	=	$\frac{100 \times (W_3 - (W_1 \times C_1))}{W_2}$
Where:	W ₁	= Bag tare weight
	W ₂	= Sample weight
	W ₃	= Weight of Organic Matter (loss of weight on ignition of bag and fiber)
	C ₁	= Ash corrected blank bag factor (running average of loss of weight on ignition of blank bag / original blank bag)

Rinse Pump Feature

In cases where the water supply pressure is too low, the instrument may show a 'Low Pressure' fault. The Rinse Pump Feature will allow the Instrument to pump the rinse water rather than use standard water pressure. Enable the feature as follows:

1. Press the DOWN arrow on the user interface multiple times until the display reads "Select Rinse Pmp" then press the ENTER button. The display will then read: "Use Rinse Pump: Off V (Enter)".
2. Next press the DOWN arrow once and then ENTER. This will enable the pump to turn on during water rinses.
3. Once this feature is enabled the user MUST manually rinse the Amylase cup after an NDF run as follows:
 - a. Press the DOWN arrow on the user interface multiple times until the display reads "Select Diag." then press ENTER.
 - b. Press the DOWN arrow and press ENTER for each of the following selections:
 - Q22 Amylase
 - Q27 Fill
 - Q28 Pump
 - Q3 Drain
 - c. Manually pour 250ml of hot water into the Amylase cup to rinse the cup and the valves.
 - d. Once complete, press the STOP button, this closes the valves and turns off the pump.

NOTE: Once enabled, the feature will stay enabled until you go through Steps 1 and 2 above and select "Off". Switching the power on and off will NOT disable this feature. If the instrument is later connected to a pressurized water supply, then this feature must be disabled.

This page intentionally left blank

Periodic Maintenance

Adjust Packing Nut

Initial Maintenance after the first 10 hours of operation, and then periodic maintenance after every 80 hours of operation.

IMPORTANT: This procedure must only be performed by trained personnel. Removal of the side access cover exposes **hot surfaces, hazardous voltages, and rotating parts.**

Maintenance Alert Collector Packing Nut

1. Allow the instrument to cool.
2. Remove the side access cover from the instrument.
3. Inspect the Maintenance Alert Collector.
4. Clean any residue from the collector.

IMPORTANT: Do NOT insert the Bag Suspender into the instrument for this procedure.

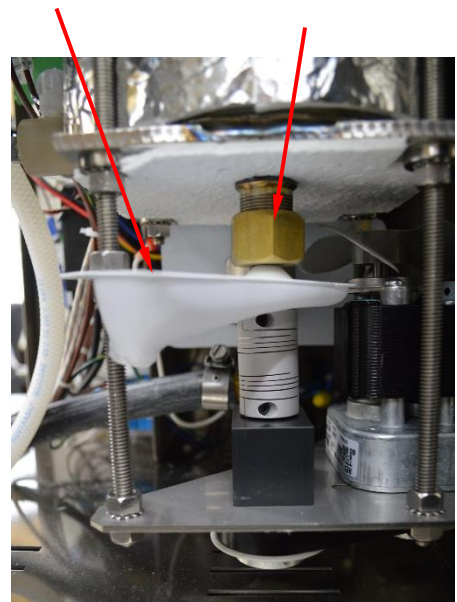

Side view of instrument with door removed

5. Press the arrow keys on the Keypad until you see "Diag Mode" on the Display. Press "ENTER".
- Diag Mode
^ v <Enter>
6. Use the arrow keys to scroll until you see Q5 Agitator on the screen. Press "ENTER". The motor will be activated, use caution to avoid contact with rotating parts.
 7. With the motor activated, turn the Packing Nut to the **RIGHT** until you hear a change in the sound of the motor. (The motor will start to labor as the packing nut gets harder to turn.)
 8. Loosen the Packing Nut slightly until the motor stops laboring.

- Turn off the instrument and re-install the side access cover.



Repeat the Initial Maintenance procedure (steps 1 – 10 above) at the end of 80 hours of operation. Note that the screen will automatically show a message saying, “Adjust packing nut”.

If you see a leak, execute the Initial Maintenance procedure above, tightening the Packing Nut 1/16 of a turn. If the leak continues, replace the packing and agitator.

Replace the Fuses (as needed)

To replace the fuses in the ANKOM^{DELTA} Automated Fiber Analyzer, follow the procedure detailed below.

- Turn off the instrument power and unplug the Power Cord from the outlet.
- Push in and twist the black cap counterclockwise ¼” turn to release the fuse.
- Check both fuses.
- Pull the fuse from the black fuse cap and replace as needed.

120V – 15 amp (Part#687) / 220V – 10 amp (Part#6035)

Fuses (2)



Clean the Fiber Optic Level Sensor

Using a cotton swab with alcohol, wipe the tip of the level sensor at least once per month if you use the instrument daily.

Level Sensor

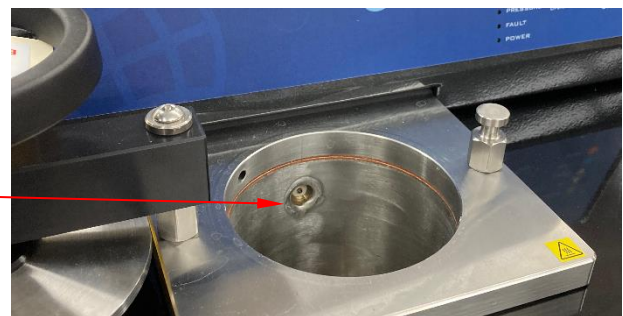

Check the Agitation System

The agitation system should be checked every three to six months or if fiber values are higher than normal or inconsistent. To check the agitation system, follow the steps below.

IMPORTANT: Poor agitation will cause higher analysis values and poor repeatability.

1. Check the function of the agitator motor.

- a. Place a bag suspender with all 9 trays in the vessel along with the bag suspender weight, but add NO water.
- b. Turn the instrument's Power Switch to the ON position. The Display will light.
- c. Press the arrow keys on the Keypad until you see "Diag Mode" on the Display. Press "ENTER".
- d. Use the arrow keys to scroll until you see Q5 Agitator on the screen. Press "ENTER".
- e. Verify that the bag suspender moves up 16 times in 15 seconds (65 rpm).
- f. Press ENTER on the Keypad to turn the agitator off.

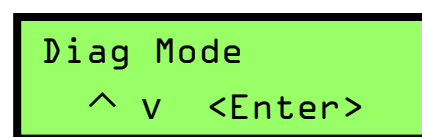
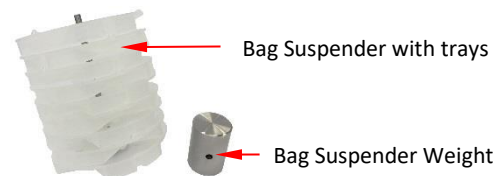

2. Mark the agitator stroke.

- a. Leaving the bag suspender in the vessel, remove the bag suspender weight.
- b. Remove the top from a dark felt tip marker and lay the marker horizontally on the top of the bag suspender so that the tip touches the inside wall of the vessel.
- c. With constant, light, downward pressure on the marker, hold the pen in place so that it rides the top tray up and down once the agitation has begun.
- d. Press the arrow keys on the Keypad until you see "Diag Mode" on the Display. Press "ENTER".
- e. Use the arrow keys to scroll until you see Q5 Agitator on the screen. Press "ENTER".
- f. Allow the bag suspender (& pen) to move up and down three or four times as the pen marks the vessel wall.
- g. Press ENTER on the Keypad to stop the agitation.

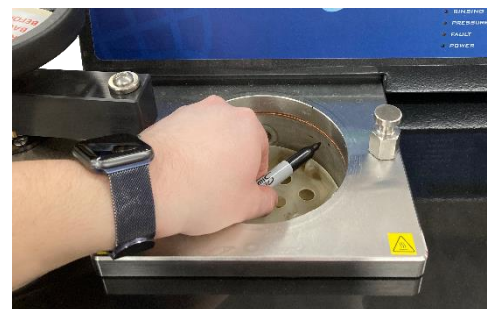

3. Measure the agitator stroke.

- a. Turn off the power switch.
- b. Remove the pen and the bag suspender from the vessel.
- c. Measure the mark on the vessel wall. It should be 1/2 inch in length.



4. Replace a worn Kynar Tip (if necessary).

If the motion is less than 1/2 inch, you will need to replace either the Bag Suspender Tip (Kynar Tip w/ washer Assembly - part # 11.5) or the agitator (Agitator Assembly - part # 8.9) because the old disc has flattened.

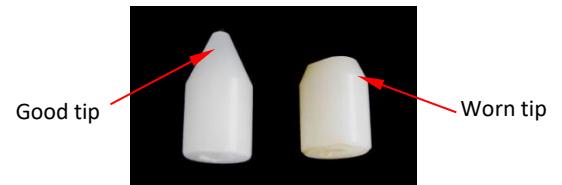

Check the Temperature Control using the Boil Test

To check the ANKOM^{DELTA} Automated Fiber Analyzer temperature control, do a Boil Test *once per month* as specified in the procedure below.

IMPORTANT: Wear appropriate personal protective equipment for heating water, such as safety goggles and heat-resistant gloves.

1. Turn on the instrument. Remove the bag suspender from the vessel.

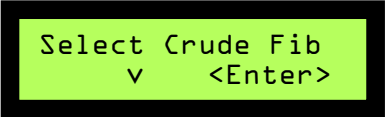

2. When you see **Select Crude Fib** on the display, press the down arrow until you see **Select Boil Test**.



3. When you see on the display, **Select Boil Test** press the ENTER button.

(Do not insert samples. Do not close lid.) Water should start to flow into the vessel.

4. Record Voltage:

- a. Record the voltage shown on the display before vessel fills. _____ V
(Should be between 5-10 VDC)
- b. Water will automatically fill to the level sensor.
- c. Record the voltage after the vessel is done filling with the water. _____ V
(Should be between 0-2 VDC)

Agitation and heat begin automatically.

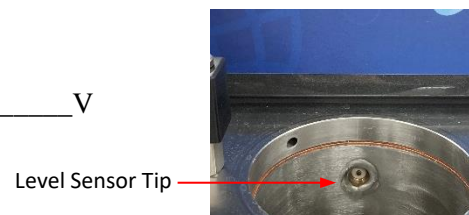

5. Do not close the lid. Occasionally stir the water to ensure uniform heating.

The water should begin to boil in 5-15 minutes.

6. When a strong boil is reached, stir the water in the vessel and record:

- a. The temperature on the controller. _____ °C
- b. The temperature on a calibrated thermometer. _____ °C
(Place the thermometer near the probe at the bottom of the vessel.)
- c. The temperature shown on the display. _____ °C

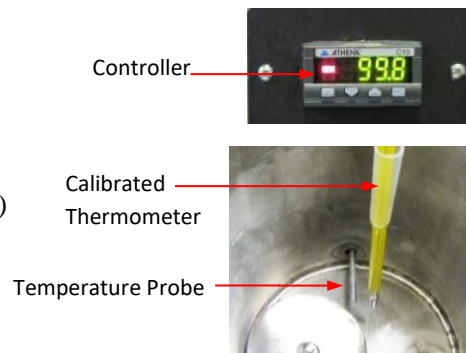

IMPORTANT: If these three temperatures are not within ½ degree of each other, contact ANKOM Technology for assistance. Send results to service@ankom.com.

Check the Bag Suspender

The bag suspender should be checked every three to six months or if fiber values are higher than normal or inconsistent. To check the Bag Suspender, follow the steps below.

1. **Verify that you are using the NEW version of the Bag Suspender Trays.**

The NEW version of the trays has 9 holes in groups of 3 as shown in the picture to the right.



NEW

OLD

IMPORTANT: You CANNOT use the new and old bag suspender trays together.

2. **Check the trays for melting.**

The pictures shown are examples of extreme cases. However, for proper operation you must replace trays that show signs of melting or wear.

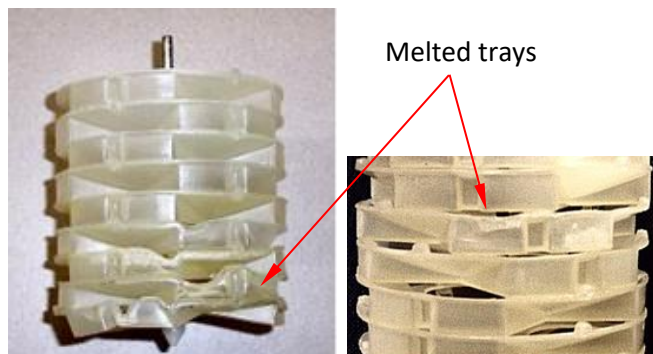

3. **Check that the bottom tray is flat.**

If the bottom tray is concave (see picture) the bag suspender will catch in the vessel and melt.

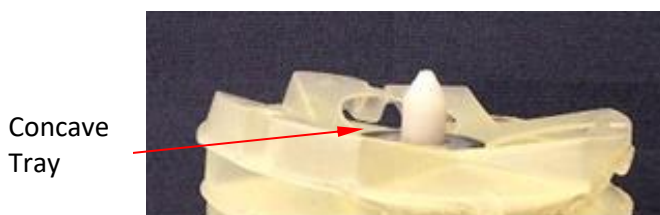

Troubleshooting & Replacement Parts

The ANKOM Technology website has the most current troubleshooting and replacement parts information. Therefore, if you have any questions about the operation of your ANKOM^{DELTA} Automated Fiber Analyzer, or if you need replacement parts, please visit our web site at www.ankom.com.

Appendix A - Analytical Procedures

IMPORTANT: While infrequent, procedures may be updated with new information. For the most up-to-date procedure revision refer to: <https://www.ankom.com/analytical-methods-support/fiber-analyzer-delta>.

Acid Detergent Fiber in Feeds - Filter Bag Technique (for DELTA)

Definition

This method determines Acid Detergent Fiber, which is the residue remaining after digesting with H₂SO₄ and CTAB. The fiber residues are predominantly cellulose and lignin.

Scope

This method is applicable to grains, feeds, forages, and all fiber-bearing material.

Apparatus

1. Analytical Balance—capable of weighing 0.1 mg.
2. Oven—capable of maintaining a temperature of 102 ± 2°C.
3. Digestion instrument—capable of performing the digestion at 100 ± 0.5°C and maintaining a pressure of 10-25psi. The instrument must be capable of creating a similar flow around each sample to ensure uniformity of extraction (ANKOM²⁰⁰⁰ with 65rpm agitation, ANKOM Technology).
4. Filter Bags—constructed from chemically inert and heat resistant filter media, capable of being heat sealed closed and able to retain 25-micron particles while permitting solution penetration (F57 and F58, ANKOM Technology).
5. Heat sealer—sufficient for sealing the filter bags closed to ensure complete closure (HS or HSi, ANKOM Technology).
6. Desiccant Pouch—collapsible sealable pouch with desiccant inside that enables the removal of air from around the filter bags (*MoistureStop* weigh pouch, ANKOM Technology).
7. Marking pen—solvent and acid resistant (F08, ANKOM Technology).

Reagents

1. Acid Detergent Solution—Add 20g cetyl trimethylammonium bromide (CTAB) to 1L 1.00N H₂SO₄ previously standardized (premixed chemical solution available from ANKOM). Agitate and heat to aid solution.
CAUTION1: Sulfuric acid is a strong acid and will cause severe burns. Protective clothing should be worn when working with this acid. Always add acid to water and not the reverse.
CAUTION2: CTAB will irritate mucous membranes. A dust mask and gloves should be worn when handling this chemical.

Sample Preparation

Grind samples in a centrifugal mill with a 2mm screen or cutter type (Wiley) mill with a 1mm screen. Samples ground finer may have particle loss from the filter bags and result in low values.

ADF Procedure (see the ADF Analysis section of the Operator's Manual for more detail)

1. Use a solvent resistant marker to label the filter bags to be used in the analysis.

4. Include at least one empty bag in the run to determine the blank bag correction (C₁).

NOTE: A running average blank bag correction factor (C₁) should be used in the calculation of fiber. The inclusion of at least one blank bag in each run is mainly used as an indicator of particle loss. A C₁ larger than 1.0000 indicates that sample particles were lost from filter bags and deposited on the blank bag during the extraction. Any fiber particle loss from the filter bags will generate erroneous results. If particle loss is observed, then the grinding method needs to be evaluated.

5. Using a heat sealer, completely seal each filter bag closed within 4mm of the top to encapsulate the sample. NOTE: Use sufficient heat to completely seal the filter bags and allow enough cool time (2 sec) before removing each bag from the heat sealer.
6. Spread the sample uniformly inside the filter bags by shaking and flicking the bags to eliminate clumping.
7. **Pre-extract only samples containing non-roasted soybean or >5% fat:** Extract samples by placing bags with samples into a container with a top. Pour enough acetone into the container to cover the bags and secure the top.

CAUTION3: Acetone is extremely flammable. Avoid static electricity and use a fume hood when handling.

Allow bags to soak for 10 minutes. Repeat with fresh acetone. Pour out acetone and place bags on a wire screen to air-dry.

Exception – Roasted soybean: Due to the processing of roasted soy a modification to the extraction is required. Place roasted soy samples into a container with a top. Pour enough acetone into the container to cover the bags and secure the top. Shake the container 10 times and pour off the acetone. Add fresh acetone and allow samples to soak for twelve hours. After the soak time, pour out the acetone and place the bags on a wire screen to air-dry.

8. Spread the sample uniformly inside the filter bags by shaking and flicking the bags to eliminate clumping.
9. Place up to 3 bags on each of eight Bag Suspender Trays (maximum of 24 bags). Stack the trays on the center post of the Bag Suspender with each level rotated 120 degrees in relation to the tray below it. Place the empty 9th tray on top. NOTE: All nine trays must be used regardless of the number of bags being processed.

2. Weigh and record the weight of each empty filter bag (W_1) and zero the balance. NOTE: Do not pre-dry filter bags. Any moisture will be accounted for by the blank bag correction.
3. Place 0.45 – 0.50g of prepared sample in up to 23 of the bags and record the weight (W_2) of each. Avoid placing the sample in the upper 4mm of the bag.

10. Verify that the hot water supply is on, and the drain hose is securely positioned in the drain.
11. Check the Temperature Controller readout on the right side of the instrument. If the temperature is higher than 20°C, cool the Vessel as follows:
12. Fill the Vessel with cold water.
13. When the Temperature Controller reads 20°C, go to the Diagnostics (DIAG.) setting. Using the down arrow, scroll to the Drain setting. Press ENTER to drain the water.
14. If necessary, press ENTER to close the drain and repeat steps a and b.

Calculations

$$\% \text{ ADF (as-received basis)} = \frac{100 \times (W_3 - (W_1 \times C_1))}{W_2}$$

- Where:
- W_1 = Bag tare weight
 - W_2 = Sample weight
 - W_3 = Dried weight of bag with fiber after extraction process
 - C_1 = Blank bag correction (running average of final oven-dried weight divided by original blank bag weight)

ADF Procedure (continued)

15. Attach the AD solution hose to the Acid Detergent port on the instrument and then to the container of Acid Detergent solution.
16. Open the Vessel Lid and insert the loaded Bag Suspender into the Vessel and place the Bag Suspender Weight on top of the empty 9th tray to keep the Bag Suspender submerged during the digestion.
17. Follow the instructions on the ANKOM^{DELTA} display:
18. Select ADF.
19. Close the Vessel Lid.
20. Confirm hot water is on (>70°C).
21. Press START.

The AD solution will be automatically inserted, and digestion will begin.

22. When the ADF extraction and rinsing procedures are complete, open the Vessel Lid and remove the filter bags. Gently press out excess water from the bags. Place bags in a 250ml beaker and add enough acetone to cover bags and soak for 3-5 minutes.
23. Remove the filter bags from the acetone and place them on a wire screen to air-dry. Completely dry in an oven at 102 ± 2°C. (In most ovens the filter bags will be completely dry within 2-4 hours.) Do not place bags in the oven until the acetone has completely evaporated.

NOTE: When running a lignin procedure or a sequential (NDF/ADF or NDF/ADF/Lignin) with the F57 Filter Bag it is important not to dry the bags overnight after the NDF or ADF procedure. A drying timeframe of 2-4 hours at 100°C to 105°C is sufficient to thoroughly dry the bags after each procedure. Extended drying times or too high a temperature can compromise the bag's filtration media. In addition, be sure to check the water of the fourth rinse during the ADF procedure to ensure all the sulfuric acid has been removed from the bags. If litmus paper shows the presence of acid during the fourth hot water rinse, repeat until neutral.

24. Remove the filter bags from the oven and immediately place them directly into a collapsible desiccant pouch and flatten to remove any air. Cool to ambient temperature and weigh the filter bags (W_3). NOTE: Do not use a conventional desiccator container.

Neutral Detergent Fiber in Feeds - Filter Bag Technique (for DELTA)

Definition

This method determines Neutral Detergent Fiber, which is the residue remaining after digesting in a detergent solution. The fiber residues are predominantly hemicellulose, cellulose, and lignin.

Scope

This method is applicable to grains, feeds, forages, and all fiber-bearing material.

Apparatus

1. Analytical Balance—capable of weighing 0.1 mg.
2. Oven—capable of maintaining a temperature of $102 \pm 2^\circ\text{C}$.
3. Digestion instrument—capable of performing the digestion at $100 \pm 0.5^\circ\text{C}$ and maintaining a pressure of 10-25psi. The instrument must be capable of creating a similar flow around each sample to ensure uniformity of extraction (ANKOM²⁰⁰⁰ with 65rpm agitation, ANKOM Technology).
4. Filter Bags—constructed from chemically inert and heat resistant filter media, capable of being heat sealed closed and able to retain 25-micron particles while permitting solution penetration (F57 and F58, ANKOM Technology).
5. Heat sealer—sufficient for sealing the filter bags closed to ensure complete closure (HS or HSi, ANKOM Technology).
6. Desiccant Pouch—collapsible sealable pouch with desiccant inside that enables the removal of air from around the filter bags (*MoistureStop* weigh pouch, ANKOM Technology).
7. Marking pen—solvent and acid resistant (F08, ANKOM Technology).
4. Include at least one empty bag in the run to determine the blank bag correction (C_1).
NOTE: A running average blank bag correction factor (C_1) should be used in the calculation of fiber. The inclusion of at least one blank bag in each run is mainly used as an indicator of particle loss. A C_1 larger than 1.0000 indicates that sample particles were lost from filter bags and deposited on the blank bag during the extraction. Any fiber particle loss from the filter bags will generate erroneous results. If particle loss is observed, then the grinding method needs to be evaluated.
5. Using a heat sealer, completely seal each filter bag closed within 4mm of the top to encapsulate the sample. NOTE: Use sufficient heat to completely seal the filter bags and allow enough cool time (2 sec) before removing each bag from the heat sealer.
6. Spread the sample uniformly inside the filter bags by shaking and flicking the bags to eliminate clumping.
7. **Pre-extract only samples containing non-roasted soybean or >5% fat:** Extract samples by placing bags with samples into a container with a top. Pour enough acetone into the container to cover the bags and secure the top.
CAUTION2: Acetone is extremely flammable. Avoid static electricity and use a fume hood when handling. Allow bags to soak for 10 minutes. Repeat with fresh acetone. Pour out acetone and place bags on a wire screen to air-dry.

Reagents

1. Neutral Detergent Solution—Add 30g Sodium lauryl sulfate (USP), 18.61g Ethylenediaminetetraacetic disodium salt (dehydrate), 6.81g Sodium borate, 4.56g Sodium phosphate dibasic (anhydrous), and 10.0ml Triethylene glycol to 1L distilled H₂O (premixed chemical solution available from ANKOM Technology). Check that pH is from 6.9 to 7.1. Agitate and heat to aid solution.
CAUTION1: Powdered chemicals will irritate mucous membranes. A dust mask and gloves should be worn when handling these chemicals.
2. Alpha-amylase—Heat-stable bacterial alpha-amylase: activity = 17,400 Liquefon Units / ml (FAA, ANKOM Technology).
3. Sodium sulfite—Na₂SO₃, anhydrous (FSS, ANKOM Technology)
8. Spread the sample uniformly inside the filter bags by shaking and flicking the bags to eliminate clumping.
9. Place up to 3 bags on each of eight Bag Suspender Trays (maximum of 24 bags). Stack the trays on the center post of the Bag Suspender with each level rotated 120 degrees in relation to the tray below it. Place the empty 9th tray on top. NOTE: All nine trays must be used regardless of the number of bags being processed.
10. Verify that the hot water supply is on, and the drain hose is securely positioned in the drain.
11. Attach the ND solution hose to the Neutral Detergent port on the instrument and then to the container of Neutral Detergent solution.
12. Open the Vessel Lid and insert the loaded Bag Suspender into the Vessel and place the Bag Suspender weight on top of the empty 9th tray to keep the Bag Suspender submerged during the digestion.

Sample Preparation

Grind samples in a centrifugal mill with a 2mm screen or cutter type (Wiley) mill with a 1mm screen. Samples ground finer may have particle loss from the filter bags and result in low values.

NDF Procedure (see the NDF Analysis section of the Operator's Manual for more detail)

1. Use a solvent resistant marker to label the filter bags to be used in the analysis.
 2. Weigh and record the weight of each empty filter bag (W_1) and zero the balance. NOTE: Do not pre-dry filter bags. Any moisture will be accounted for by the blank bag correction.
 3. Place 0.45 – 0.50g of prepared sample in up to 23 of the bags and record the weight (W_2) of each. Avoid placing the sample in the upper 4mm of the bag.
- (Procedure continued on next page.)

Calculations

$$\% \text{ NDF (as-received basis)} = \frac{100 \times (W_3 - (W_1 \times C_1))}{W_2}$$

Where:	W_1	=	Bag tare weight
	W_2	=	Sample weight
	W_3	=	Dried weight of bag with fiber after extraction process
	C_1	=	Blank bag correction (running average of final oven-dried weight divided by original blank bag weight)

NDF Procedure (continued)

13. Follow the instructions on the ANKOM^{DELTA} display:
14. Select NDF. (**Wait** to close the Vessel Lid.)
15. Confirm hot water is on (>70°C).
16. Press START.
17. After the ND solution has been automatically inserted and agitation begins, manually add 20g of Na₂SO₃ and 4.0ml of alpha-amylase.
18. Close the Vessel Lid.
19. If there is no water in the attached Amylase Dispenser Assembly, add enough tap water to fill the cup about ½ full. Add 8.0ml of alpha-amylase and enough water to fill the dispenser about ¾ full. The second addition of water will thoroughly mix the amylase and water. The instrument will automatically add the amylase solution to the first and second rinse.
20. When the NDF extraction and rinsing procedures are complete, open the Vessel Lid and remove the filter bags. Gently press out excess water from the bags. Place bags in a 250ml beaker and add enough acetone to cover bags and soak for 3-5 minutes.
21. Remove the filter bags from the acetone and place them on a wire screen to air-dry. Completely dry in an oven at 102 ± 2°C. (In most ovens the filter bags will be completely dry within 2-4 hours.) Do not place bags in the oven until the acetone has completely evaporated.
 NOTE: When running a lignin procedure or a sequential (NDF/ADF or NDF/ADF/Lignin) with the F57 Filter Bag it is important not to dry the bags overnight after the NDF or ADF procedure. A drying timeframe of 2-4 hours at 100°C to 105°C is sufficient to thoroughly dry the bags after each procedure. Extended drying times or too high a temperature can compromise the bag's filtration media. In addition, be sure to check the water of the fourth rinse during the ADF procedure to ensure all the sulfuric acid has been removed from the bags. If litmus paper shows the presence of acid during the fourth hot water rinse, repeat until neutral.
22. Remove the filter bags from the oven and immediately place them directly into a collapsible desiccant pouch and flatten to remove any air. Cool to ambient temperature and weigh the filter bags (W_3). NOTE: Do not use a conventional countertop or cabinet desiccator.

Crude Fiber Analysis in Feeds - Filter Bag Technique (for DELTA, DELTAI, A200, A200I, A2000 and A2000I)

Definition

This method determines Crude Fiber which is the organic residue remaining after digesting with 0.255N H₂SO₄ and 0.313N NaOH. The compounds removed are predominantly protein, sugar, starch, lipids, and portions of both the structural carbohydrates and lignin.

Scope

This method is applicable for all feed materials such as grains, meals, pet foods, mixed feeds, forages, and the following oilseeds: corn and soybeans.

ABSTRACT

AOCS Ba 6a-05 is used for the determination of crude fiber in grains, meals, pet foods, mixed feeds, forages, oilseeds (such as corn and soybeans) and fiber-bearing material from which fat can be extracted to leave workable residue. Crude fiber is the loss on ignition of the dried residue remaining after digestion of the sample in 0.255N H₂SO₄ and 0.313N NaOH solutions under specific conditions. Samples are prepared and ground to a uniform fineness (e.g. Wiley 1mm screen or 2mm cyclone mill). One gram samples are sealed in F57 or F58 filter bags and pre-extracted in a beaker with ether. Up to 24 pre-extracted samples are placed in a bag suspender and inserted into the Fiber Analyzer for processing. The instrument then automatically performs all the necessary procedural steps to digest the samples and rinse them. Samples are then ashed and reported on organic matter basis.



Complete operational details are available in the ANKOM Operator's Manuals.

AOCS Method Ba 6a-05 can be obtained directly from [AOCS](#)

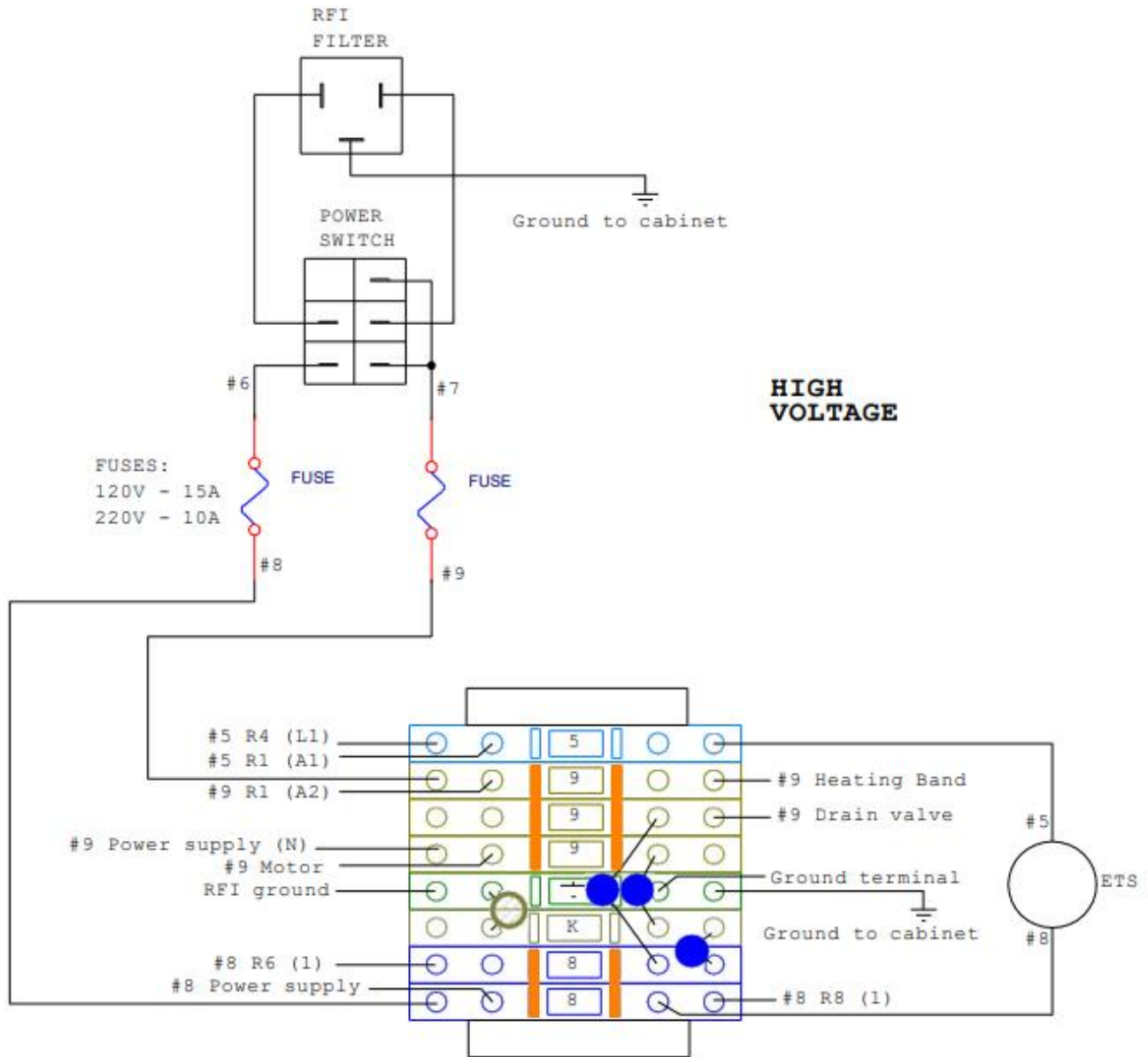
Appendix B – Wiring Diagrams (1 of 6)



#x = wire number
 Rx = relay number
 (Ax) = wire position on relay

 MOV #51.5-VZ14D471KBS
 SPARK GAP #51.2-Y08SV-272B

ANKOM Technology			
Title A2000 DELTA SCHEMATIC 120/220V			
Size	Document Number HIGH VOLTAGE		Rev A
Date:	March 10, 2020	Sheet	1 of 6

Appendix B – Wiring Diagrams (2 of 6)

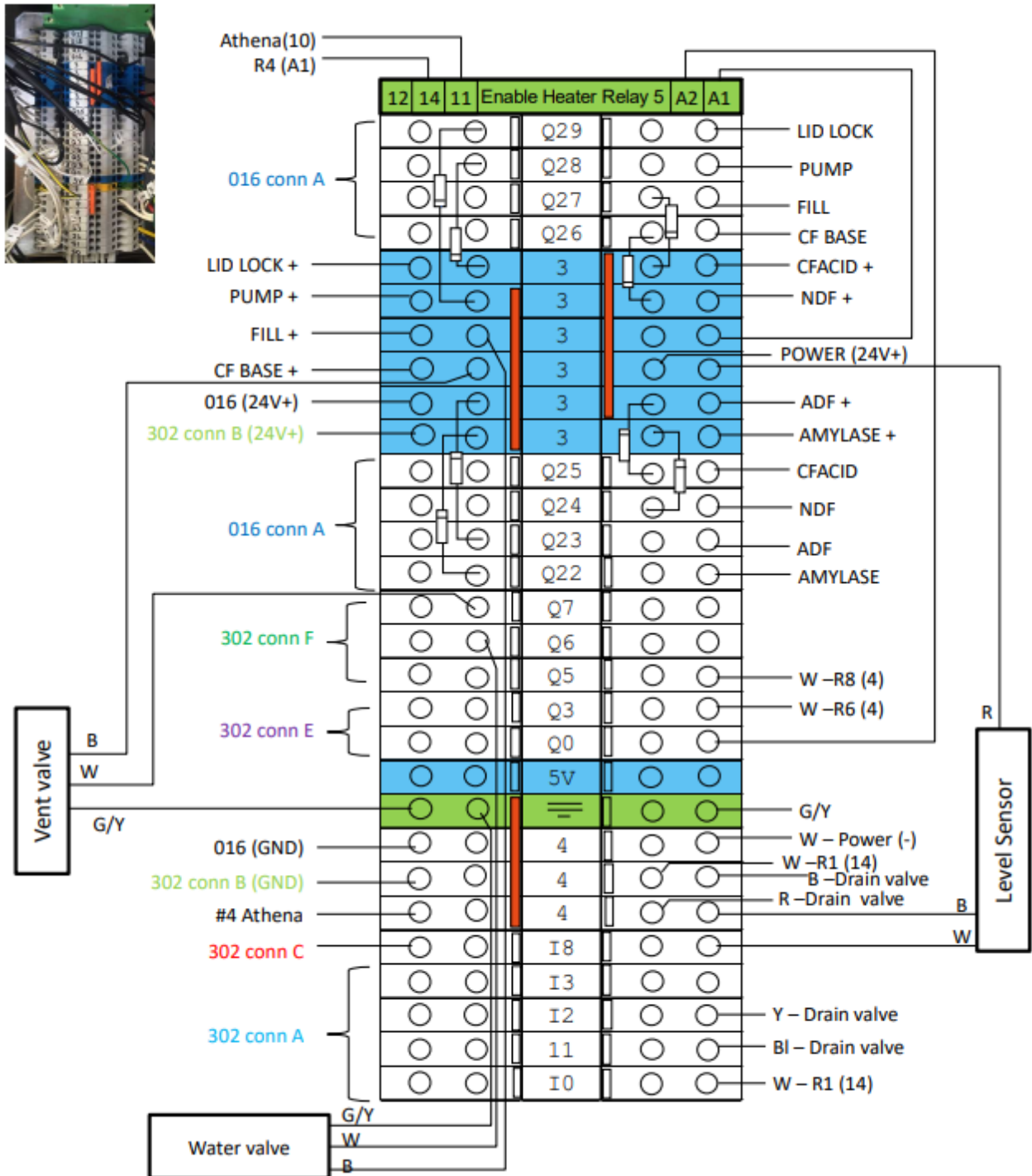

ANKOM Technology			
Title A2000 DELTA SCHEMATIC 120/220V			
Size	Document Number	LV Terminal Block	
Date:	March 10, 2020	Sheet	2 of 6
			Rev A

Appendix B – Wiring Diagrams (3 of 6)

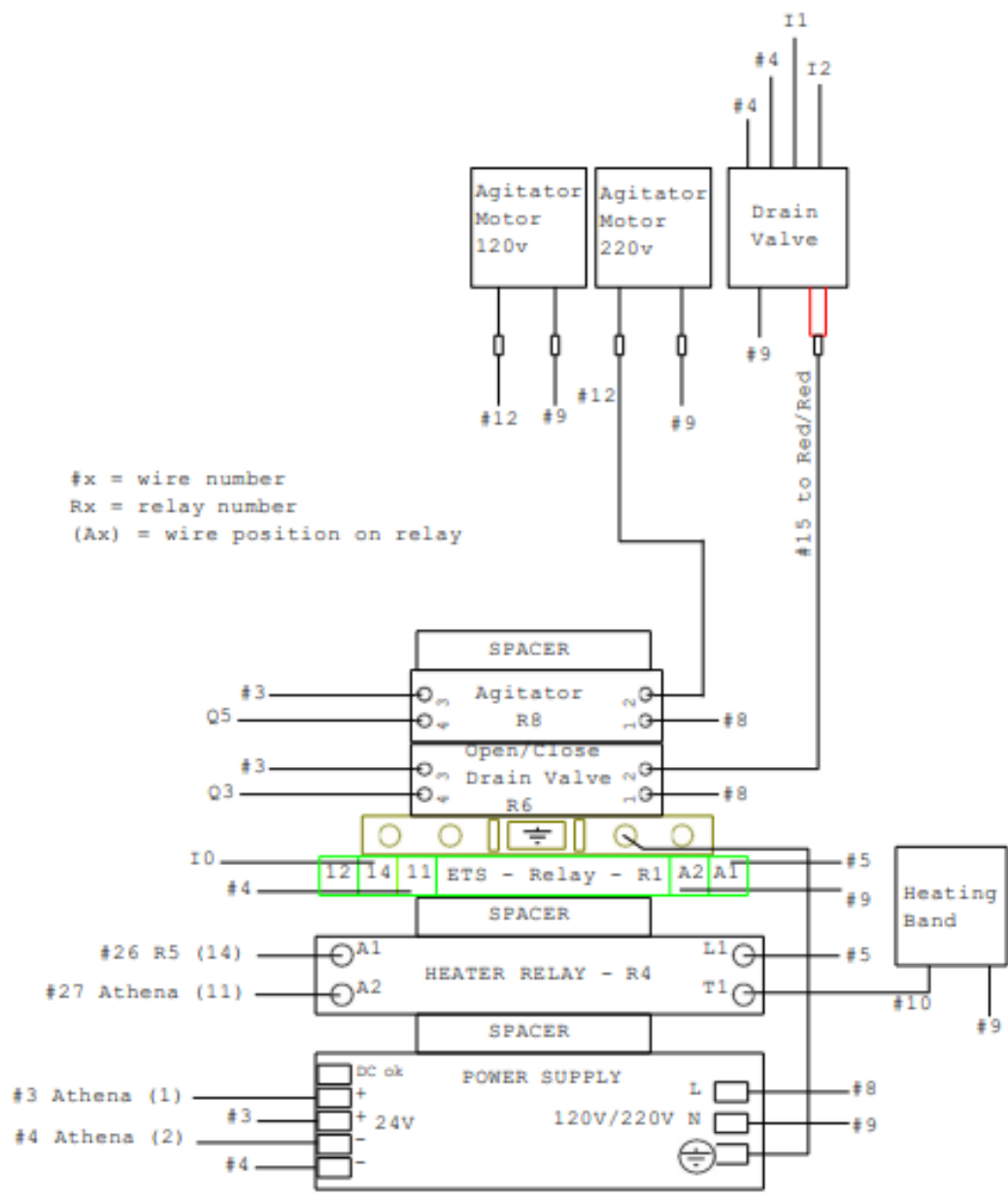

ANKOM Technology			
File A2000 DELTA SCHEMATIC 120/220V			
Size	Document Number	RELAY DIN RAIL	Rev A
Date:	March 10, 2020	Sheet	3 of 6

Appendix B – Wiring Diagrams (4 of 6)

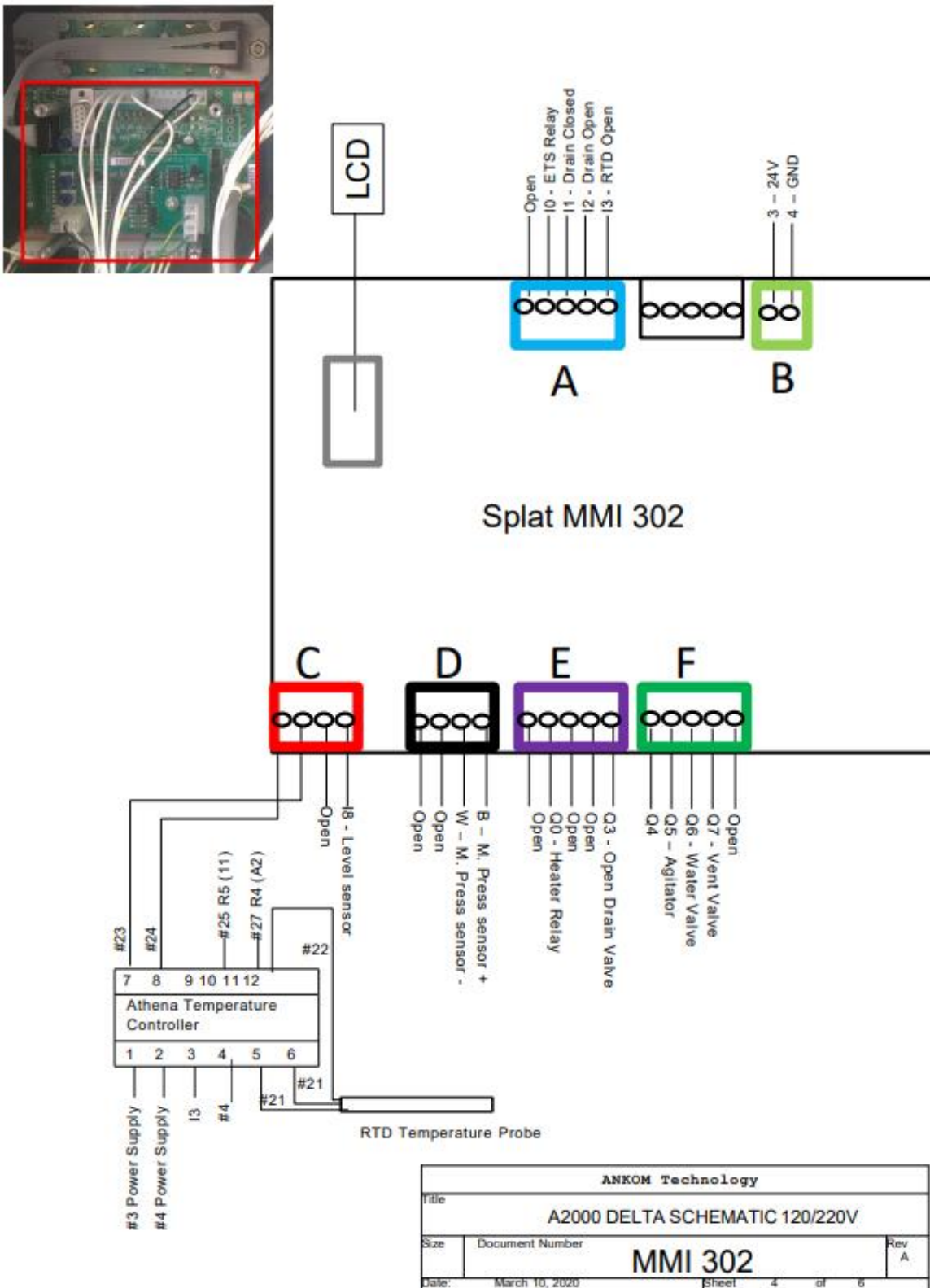

Appendix B – Wiring Diagrams (5 of 6)

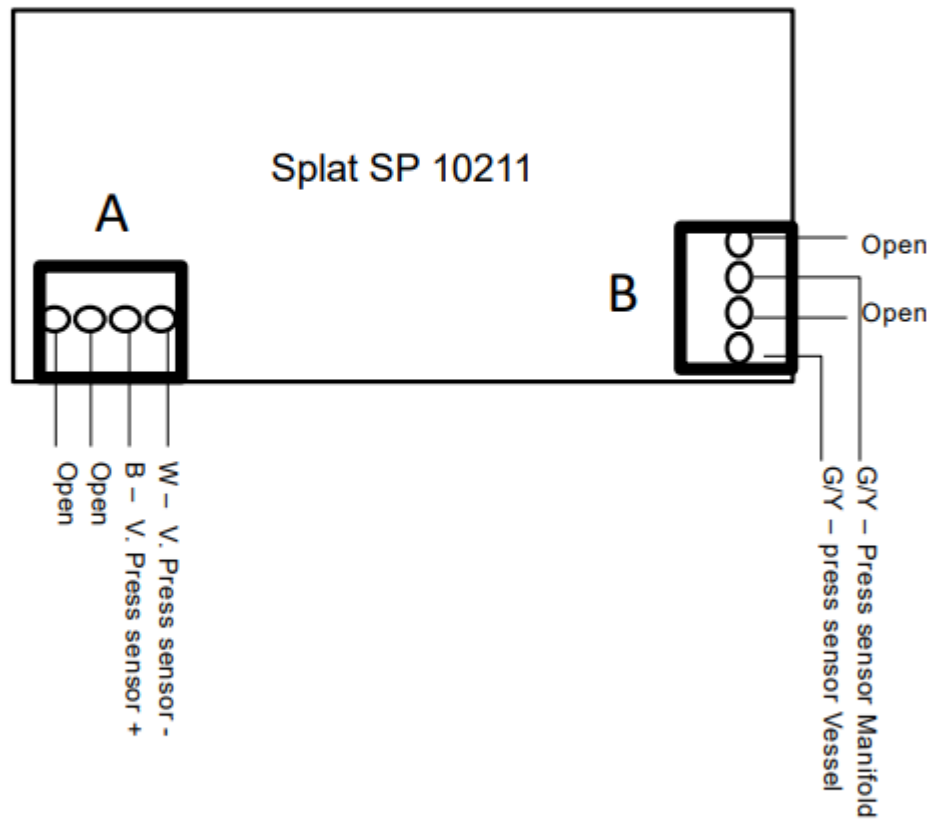
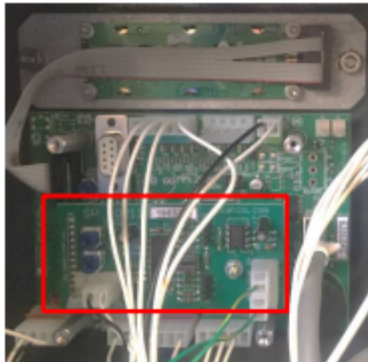

ANKOM Technology			
Title			
A2000 DELTA SCHEMATIC 120/220V			
Size	Document Number		Rev
	SP 10211		A
Date:	March 10, 2020	Sheet	5 of 6



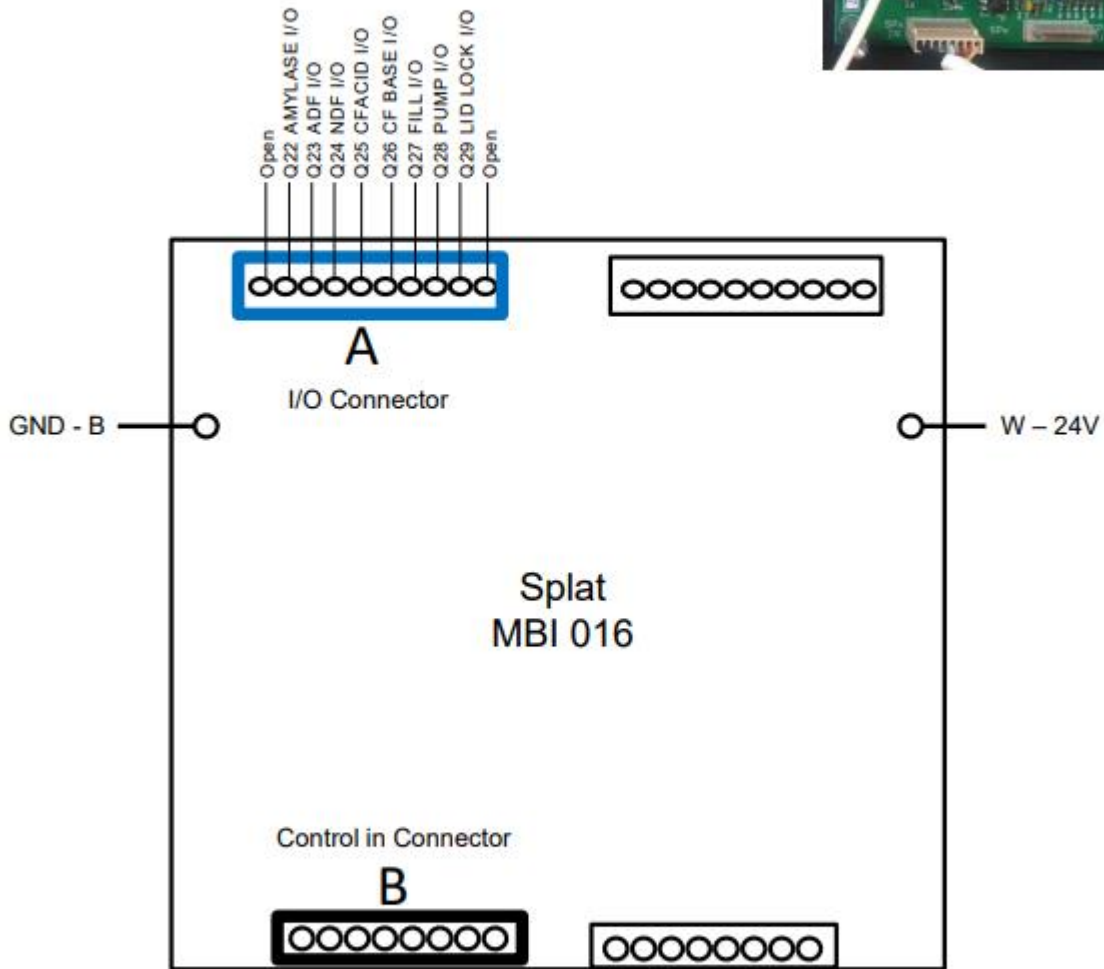

Appendix B – Wiring Diagrams (6 of 6)



ANKOM Technology			
Title			
A2000 DELTA SCHEMATIC 120/220V			
Size	Document Number		Rev
	MBI 016		A
Date:	March 10, 2020	Sheet	6 of 6

Automation saves time and money!

ANKOM Technology is an international company with products that include...

	<p>FLEX Analyte Extractor</p> <ul style="list-style-type: none"> • Simplifies fat-soluble vitamin and cholesterol analysis • Crude and total fat analysis capability coming soon • Eliminates chemical handling to improve safety • Eliminates bi-phase extractions • Provides ability to create custom methods
	<p>TDF Dietary Fiber Analyzer</p> <ul style="list-style-type: none"> • Automates AOAC 991.43, 985.29, 2009.01, and 2011.25 (and associated AACC methods) • IDF/SDF and TDF values • Faster, Technician-free Filtering • Computer controlled operation • Reduced per assay costs
	<p>XT15 Fat Extractor</p> <ul style="list-style-type: none"> • Official Method AOCS Am 5-04 • Fully automatic • Solvent recovery at 97% or greater • Batch process - up to 15 samples at one time
	<p>RF Gas Production System</p> <ul style="list-style-type: none"> • High sensitivity pressure measurement • Anaerobic activity analyses (rumen, yeast, beer/wine fermentation, etc.) • Biodegradability analyses • Aerobic activity analyses (BOD, soil respiration, etc.) • Wireless Computer control and data storage
	<p>Chemicals</p> <ul style="list-style-type: none"> • A wide variety of chemicals used for many different lab operations • Pre-mixed solutions available

Please visit our web site at www.ankom.com for more information.

2052 O'Neil Rd, Macedon NY 14502
 Telephone: (315) 986-8090
 Fax: (315) 986-8091
www.ankom.com

ANKOM
 TECHNOLOGY