



Rev 05/31/24

This page intentionally left blank

Table of Contents

Introduction	5
Warranty.....	5
Filter Bags	5
Operating Environment	5
Contact Information	5
Instrument Description.....	7
Safety Precautions	9
Instrument Installation	10
Fiber Analysis Support Items	11
Analysis Options using the ANKOM ²⁰⁰ Fiber Analyzer	11
ADF Analysis.....	13
NDF Analysis	19
Crude Fiber Analysis	23
Periodic Maintenance.....	29
Storage.....	34
Troubleshooting & Replacement Parts.....	35
Appendix A- Analytical Procedures.....	36
Appendix B – Wiring Diagram.....	42
Appendix C- Timer Operating Instruction.....	43

This page intentionally left blank

Introduction

ANKOM Technology designs, manufactures, and markets instruments and support products used by analytical laboratories around the world in the environmental, agricultural, biomass, and food industries. ANKOM Technology can provide you with products for determining or monitoring detergent fibers, dietary fibers, fat, digestibility, microbial fermentation (anaerobic or aerobic) and more.

Committed to Total Customer Satisfaction, ANKOM designs every product based on a thorough assessment of customer needs.

Congratulations on your purchase of the ANKOM²⁰⁰ Fiber Analyzer. We are confident that this product will effectively serve your needs.

By carefully following the operating instructions in this manual, you will minimize errors in results. Experience indicates that errors in results are usually associated with minor variations in carrying out the procedure. This manual will provide you with details that will help assure accuracy of your results.

NOTE:	Please review the entire contents of this manual before you begin operating this product.
--------------	---

Warranty

ANKOM Technology warrants the ANKOM²⁰⁰ Fiber Analyzer against any defects due to faulty workmanship or material for one year after the original date of purchase. This warranty does not include damage to the instrument resulting from neglect or misuse. During the warranty period, should any failure result from defects in workmanship or materials, ANKOM Technology will, at its discretion, repair or replace the instrument free of charge.

Extended warranties are available for purchase if desired.

Filter Bags

ANKOM Technology filter bags (part # F57 and F58) are designed to produce precision and accurate fiber results. The F57 bags should be used when grinding samples using a cutter type mill with a 1 mm screen which is typically referenced by the approved methods. For finer ground samples or if particle loss is suspected, use the F58 bags which have a finer pore size.

Use of other types of filtration media not tested and approved by ANKOM Technology may cause damage to electrical valves and other components and void your warranty. Filter bags can be purchased from ANKOM Technology or from your local authorized ANKOM distributor.

Operating Environment

Your ANKOM²⁰⁰ Fiber Analyzer is designed to operate within the following environments:

- Ambient Temperature Range: 15°–30°C
- Humidity: 20–60% RH
- Power (domestic): 110V–120V ~ 50/60Hz 15A
- Power (international): 220V–240V ~ 50/60Hz 10A

Contact Information

At ANKOM Technology we are committed to your total satisfaction and therefore always available to help you get the most from your ANKOM products. We are also very interested in any comments or suggestions you may have to help us improve.

For any questions or suggestions regarding your instrument, please contact us at:

For Sales Support: sales@ankom.com or <https://www.ankom.com/contact-us>

For Technical Support: www.ankom.com/contact/technical-services

For Analytical Support: www.ankom.com/contact/analytical-services

Telephone: (315) 986-8090 Fax: (315) 986-8091

This page intentionally left blank

Instrument Description

General Description

The ANKOM²⁰⁰ Fiber Analyzer is designed to efficiently and accurately determine Acid Detergent Fiber (ADF), Neutral Detergent Fiber (NDF), and Crude Fiber within food and/or feed samples. Enabled by Filter Bag Technology, up to 24 samples can be processed at one time.

During analysis cell contents are removed as the encapsulated sample is subjected to the appropriate chemical (AD, ND, or crude fiber acid and base) solutions, leaving the desired fiber fraction. Results are determined gravimetrically. The filter bags are designed to allow proper flow of solutions while retaining non-soluble components. The fiber residue captured in the filter bag can be used for follow-on assays such as ADIN, NDIN, and ADL.

Like the ANKOM²⁰⁰⁰ Fiber Analyzer, digestion and rinse operations are all performed within the same instrument, allowing for the elimination of the separate filtration step. Process temperatures are precisely controlled while providing proper agitation to ensure a uniform flow of chemical solutions and rinses across each sample.

Below are descriptions of specific features and functions of the ANKOM²⁰⁰ Fiber Analyzer.

- The Exhaust Valve Handle opens and closes the Exhaust Valve which exhausts the pressure and solution from the Vessel.
- The Exhaust Hose drains solution from the instrument into a suitable drain or waste container.
- The Temperature Controller controls the temperature inside the Vessel. The controller is preset at the factory and does not require any initial adjustment.
- The Timer/Clock has four adjustable countdown settings and a clock function. Refer to Appendix B.

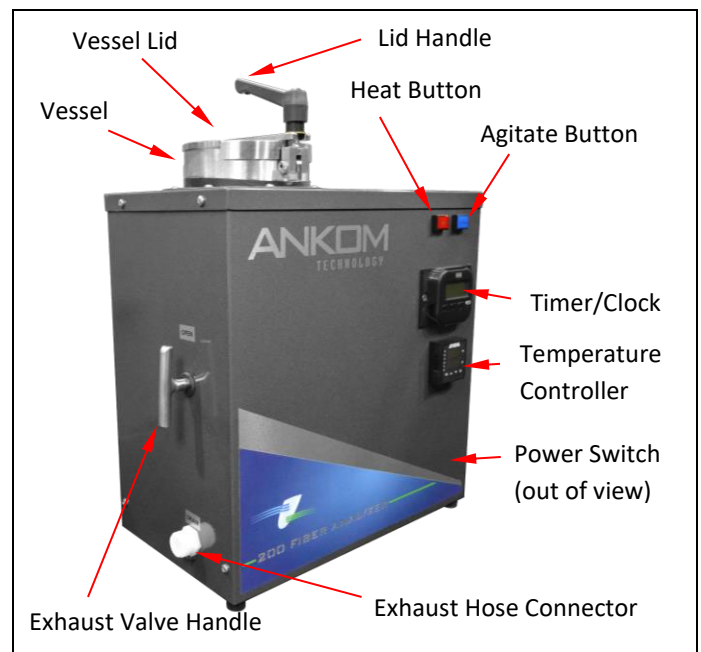

IMPORTANT: The Timer/Clock does NOT control any function within the instrument. Although an audible alarm will sound when the timer has counted down, the instrument will continue what it was doing when the alarm sounded.

- The **AGITATE** button controls the movement of the agitator. The agitator aids the flow of solution through the filter bags by raising and lowering the bag suspender in the Vessel.
- The **HEAT** button turns on and off the Temperature Controller in order to provide the appropriate heat to the solutions within the Vessel.

IMPORTANT: Do NOT turn the heat on unless the vessel contains an appropriate amount of liquid.

Internal Components (Rear View)

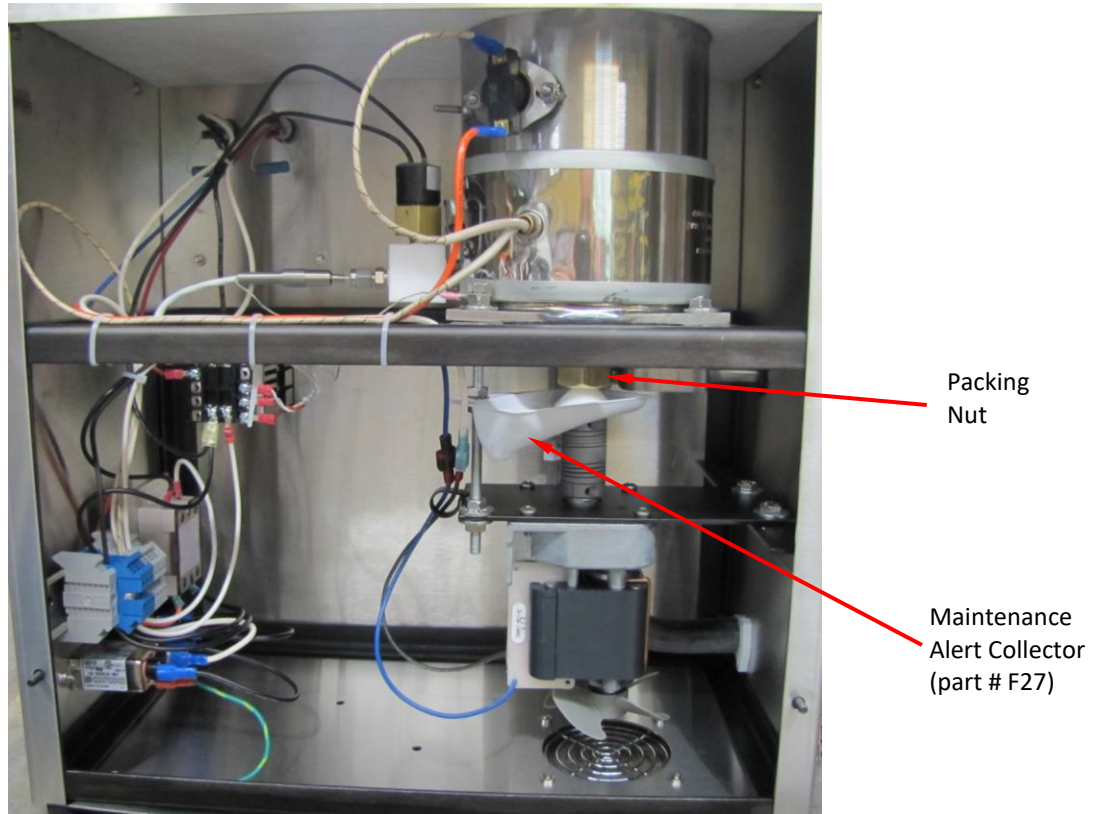

External Components (Rear View)

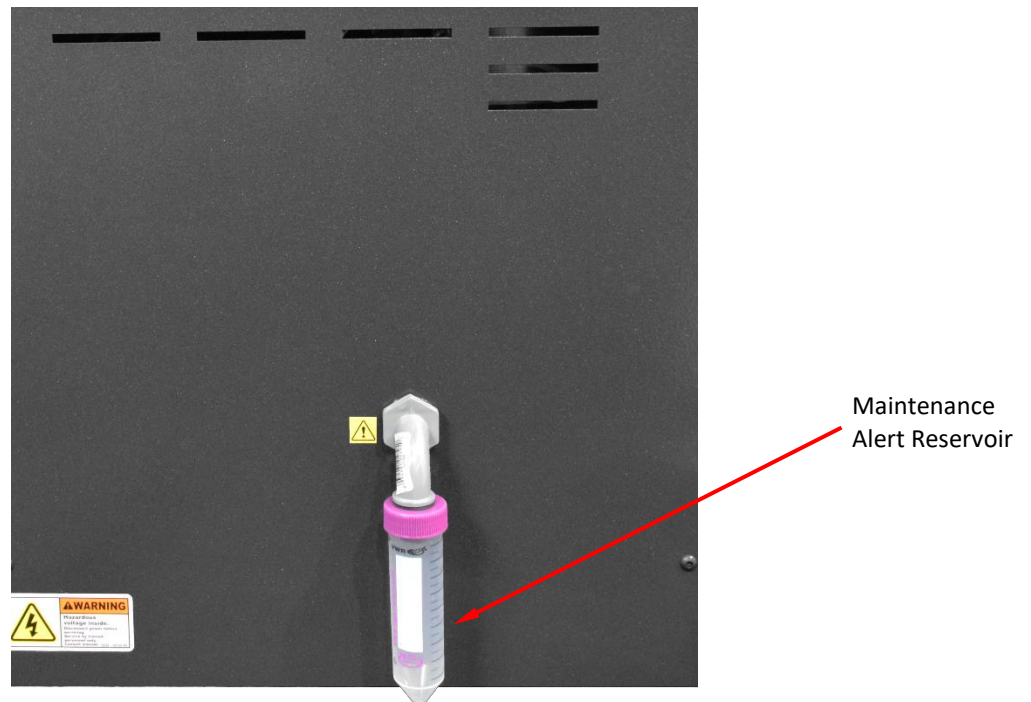

Safety Precautions



Hazardous Pressure – The contents of the Vessel are hot and under pressure. Do NOT open the Vessel Lid during or after an operation until both pressure and liquid are fully exhausted from the instrument. Connect and secure the Drain Hose along the path to the drain so it will not move when hot pressurized fluid is exhausted. **Failure to observe this caution may result in uncontrolled chemical flow, scalding, or burning.**

Hot Surfaces – Do NOT touch the Vessel surfaces during operation. The surface can exceed 70°C (158°F). **Failure to observe this caution may result in burning.**

Hazardous Voltages – Do NOT operate the instrument with the cover removed. Hazardous voltages are present during operation. The Power Cord must be disconnected prior to removal of the rear panel. **Failure to observe this caution may result in electrical shock or electrocution.**

Hazardous Materials – Do NOT operate the instrument without the Maintenance Alert Collector and Maintenance Alert Reservoir in place. Caution should be used when handling hot effluent that may be caustic or corrosive. If necessary, the solution can be collected in a container and neutralized before disposal. Follow safe laboratory practices according to your local regulations when installing and using this instrument and associated chemicals.

WARNING: Attempts to override safety features or to use this instrument in a manner not specified by ANKOM Technology voids the warranty and may result in serious injury or even death.

This system is designed to meet and/or exceed the applicable standards of CE, CSA, NRTL and OSHA.

IMPORTANT:

- The Power Switch must be in the OFF position before plugging the instrument Power Cord into the power source.
- In the event of an instrument malfunction, the internal heater will be automatically turned off by one of the following safety devices:
 - 1) Electrical Fuses
 - 2) The Emergency Temperature Shut-off Switch (ETS)
 - 3) The Pressure Transducer

NOTE:

Please review the entire contents of this manual before you begin operating this instrument.

Instrument Installation

Site Requirements

To install and operate the ANKOM²⁰⁰ Fiber Analyzer you will need the following:

- Adjustable wrench
- Water supply and capability of heating water to 50°C for Crude Fiber and 70°C for ADF/NDF analyses
- Adequate power (see “Operating Environment” section)
- Drain

Instrument Installation Procedure

To install the ANKOM²⁰⁰ Fiber Analyzer, follow the procedure detailed below.

1. Remove the instrument from the shipping container and place it in an area that is within six feet of a drain and on a surface that is firm and level. The instrument must not be subject to excessive shock, vibration, dirt, moisture, oil, or other fluids.

IMPORTANT: Do NOT place this instrument near microwave ovens or mechanical devices.

Your instrument comes complete with an Exhaust Hose, a Power Cord, and a Bag Suspender Assembly (including Bag Suspender Trays and a Bag Suspender Weight).



The Bag Suspender has a total of nine trays. Eight of the trays hold up to three filter bags per tray. The ninth tray is used as a cover. The weight is used to keep all of the trays together as the Bag Suspender moves up and down inside the Vessel during operation.

2. Connect and secure the Exhaust Hose so that it will not move when hot pressurized fluid is exhausted.
3. With the Power Switch in the OFF position, plug the Power Cord into the Power Cord Inlet on the right side of the instrument (when looking at the front).
4. Plug the Power Cord into the power source.

Fiber Analysis Support Items

The following support items are needed to perform the fiber analysis procedures:

Item	Recommended Product
Filter Bags	ANKOM #F57, #F58
Bag Holder (used for adding sample to an empty filter bag)	ANKOM #X20
Heat Sealer for sealing the filter bags	ANKOM #HS (120V), #HSi (220V)
Solvent Resistant Marker	ANKOM #F08
Desiccant Pouch	ANKOM #X45
Oven for drying (capable of maintaining 102°C ± 2°)	ANKOM #RD (120V), #RDI (220V)
Sample	-----
Spoon	-----

Analysis Options using the ANKOM²⁰⁰ Fiber Analyzer

The ANKOM²⁰⁰ Fiber Analyzer can be used for ADF, NDF, and Crude Fiber analyses.

The following sections provide the information you will need to use and maintain the ANKOM²⁰⁰ Fiber Analyzer.

This page intentionally left blank

ADF Analysis

ADF Calculation

ADF contained within a food or feed sample can be calculated using the following formula:

% ADF (as-received basis)	=	$\frac{100 \times (W_3 - (W_1 \times C_1))}{W_2}$
Where:		
	W_1	= Bag tare weight
	W_2	= Sample weight
	W_3	= Dried weight of filter bag with fiber after extraction process
	C_1	= Blank bag correction (running average of final oven-dried weight divided by original blank bag weight)

ADF Sample Preparation Procedure

To prepare samples for fiber analysis, follow the procedure detailed below.

IMPORTANT: When using the ANKOM²⁰⁰ Fiber Analyzer for ADF analysis, at least one blank filter bag should be included with the sample set as an indicator of particle loss. A running average of the blank bag weights is used in the fiber calculation as the C_1 correction factor. A C_1 value larger than 1.0000 indicates that sample particles were lost from filter bags and deposited on the blank bag. Any fiber particle loss from the filter bags will generate erroneous results. If particle loss is observed, the grinding method for the specific sample should be evaluated.

- Using a Solvent Resistant Marker, number all of the filter bags you will use during the fiber analysis. Allow the marker to dry on the filter bags.
- Weigh and record the weight of each empty filter bag (W_1).
- Set the Heat Sealer dial to between 4 and 5. (The setting may vary from sealer to sealer.)



- Seal at least one empty filter bag (to be used as a blank) within 4mm of its open end. Keep the sealer arm down for 2 – 3 seconds after the red sealer light turns off (to cool the seal). The seal can be seen as a solid melted stripe along the top edge of the filter bag (as shown to the right). If the seal is not strong, re-seal the bag.



- Place an empty filter bag in the Bag Holder in an open position.

6. Tare the weight of the empty filter bag and the holder together.
7. Add 0.45 – 0.50g of sample to the filter bag. Keep all particles away from the sealing area of the filter bag.
8. Record the weight of the sample (W_2).
9. Seal the filter bag within 4mm of its open end. Keep the sealer arm down for 2 – 3 seconds after the red sealer light turns off (to cool the seal). The seal can be seen as a solid melted stripe along the top edge of the filter bag. If the seal is not strong, re-seal the bag.
10. To eliminate sample clumping, spread the sample out uniformly within the filter bag by shaking and flicking the bag.
11. Repeat steps 5 – 10 for all filter bags that will be used in the Analyzer. (Up to 24 bags can be processed during one procedure with one of the bags being a blank.)
12. Follow these pre-extraction steps for specified samples.

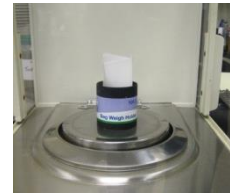

- a. **If your samples contain non-roasted soybean or >5% fat:**
 Before doing the ADF analysis in the ANKOM^{DELTA}, you will need to do a pre-extraction. For samples containing non-roasted soybean or >5% fat, follow the pre-extraction steps below:
 - 12.1.1 Place the filter bags with sample (up to 23) into a container with a top.
 - 12.1.2 Pour enough fresh acetone into the container to cover the bags.
 - 12.1.3 Put the top on the container.
 - 12.1.4 Allow bags to soak for 10 minutes.
 - 12.1.5 Pour out and dispose of the acetone.
 - 12.1.6 Execute steps 1 through 5 a total of two times.
 - 12.1.7 Place the bags on a wire screen to air-dry.
- b. **If your samples contain roasted soybean:**
 Before doing the ADF analysis in the ANKOM^{DELTA}, you will need to do a pre-extraction. For samples containing roasted soybean, follow the pre-extraction steps below:
 - 12.2.1 Place the filter bags with sample (up to 23) into a container with a top.
 - 12.2.2 Put the top on the container.
 - 12.2.3 Shake the container 10 times.
 - 12.2.4 Allow the samples to soak for twelve hours.
 - 12.2.5 Pour out the acetone.

Place the bags on a wire screen to air-dry.

13. If the sample has settled to the bottom of the bag, spread the sample uniformly inside the filter bags by shaking and flicking the bags to eliminate clumping.
14. Place the filter bags with sample and at least one empty bag (used as a blank) into the Bag Suspender trays as shown (maximum of three bags per tray).
15. Stack each tray on the Bag Suspender rod (eight trays in total) with each tray rotated 120 degrees from the tray below.



IMPORTANT: You must use all eight trays even if they are empty.

16. Add the ninth tray to the top of the Bag Suspender rod. This tray contains no filter bags and acts as a cover.

NOTE: The samples are now ready for the ADF analysis procedure.

ADF Analysis Procedure using the ANKOM²⁰⁰ Fiber Analyzer

NOTE: If you are following the acid detergent procedure with an acid detergent lignin, you can find the lignin procedure on our website at www.ankom.com.

To perform the ADF analysis on prepared samples, follow the procedure detailed below.

IMPORTANT: The Vessel must be at room temperature before beginning an ADF analysis.

1. Verify that the Exhaust Hose is connected to the instrument and securely positioned in the drain.
2. Turn the instrument Power Switch to the ON position.
3. Lift the Lid Handle to open the Vessel Lid.
4. If the temperature on the Temperature Controller display is higher than room temperature, fill the Vessel with cold tap water. The temperature on the Controller will decrease. When the value on the Controller reaches its lowest number and starts to increase, open the Exhaust Valve and exhaust the water. Repeat this process until the number on the Temperature Controller equilibrates to room temperature.
5. Place the Bag Suspender with the samples and the Bag Suspender Weight into the Vessel.
6. Pour a maximum of 2 L of Acid Detergent solution into the Vessel.
7. Press the **HEAT** and **AGITATE** buttons on the front of the instrument so they are lit. Look in the Vessel to confirm agitation.
8. Close the Vessel Lid.
9. On the Timer/Clock, set the Timer to 60 minutes and press the Start/Stop button.
10. When the Timer sounds, the digestion process is complete. Press the **HEAT** and **AGITATE** buttons to turn them off (the buttons will not be lit when they are off). Open the Exhaust Valve (slowly at first) and exhaust the hot solution **BEFORE** opening the Vessel Lid.

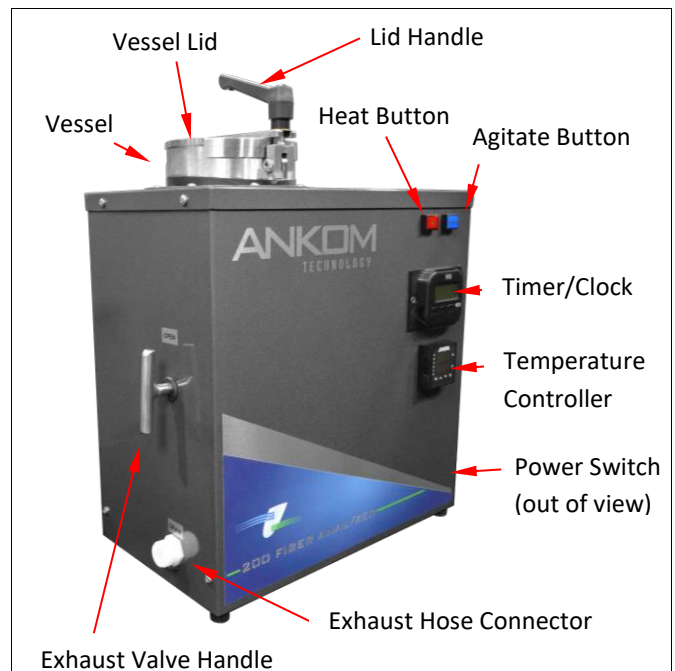

IMPORTANT: Because the Vessel is under pressure, the Exhaust Valve must be opened to release the pressure and the solution **BEFORE** opening the Vessel Lid.

11. After the solution has been exhausted, open the Vessel Lid slowly to allow air to push any remaining liquid out the Exhaust Hose.
12. Close the Exhaust Valve.
13. Add 1900 ml - 2000 ml of 70°C - 90°C rinse water.

IMPORTANT: During the rinse process, if the **HEAT** button is OFF, the Vessel Lid can be open. If the **HEAT** button is ON, the Vessel Lid must be closed.

14. Press the **AGITATE** button.
15. On the Timer/Clock, set the Timer to 5 minutes and press the Start/Stop button.

16. When the Timer sounds, the rinse is complete. Slowly open the Exhaust Valve to drain the hot water.
17. Repeat steps 12 - 16 to accomplish the second rinse.
18. Make sure that the **HEAT** button is off (not lit) so that pH can be checked after the third rinse.
19. Repeat steps 12 - 16 to accomplish the third rinse.
20. After the third rinse, open the Vessel Lid and check that the water is pH neutral. If the water is NOT pH neutral, repeat steps 12 - 16 until the pH is neutral.
21. When the rinsing process is complete, remove the Bag Suspender from the Vessel.
22. Remove the bags from the Bag Suspender trays and place them in an appropriately sized beaker.
23. With your hands, gently press out excess water from the bags into the beaker and pour off the water from the beaker.
24. With the bags in a beaker, add enough acetone to cover them. Let the bags soak in acetone for 3 - 5 minutes. Pour off the acetone.
25. With your hands, gently press out excess acetone from the bags into the beaker and pour off the acetone from the beaker.
26. Remove the bags from the beaker and place them on a wire screen to air-dry.



Hazardous Materials – Do NOT place bags in an oven until all acetone in the bags has evaporated.

27. Place air-dried bags in the oven and heat at $102^{\circ}\text{C} \pm 2^{\circ}$ for 2 - 4 hours (depending on the oven).

IMPORTANT: When running a lignin procedure or a sequential (NDF/ADF or NDF/ADF/Lignin) with the F57 Filter Bag it is important not to dry the bags overnight after the NDF or ADF procedure. A drying timeframe of 2-4 hours at 100°C to 105°C is sufficient to thoroughly dry the bags after each procedure. Extended drying times or too high a temperature can compromise the bag's filtration media. In addition, after the fourth rinse during the ADF procedure if you would like to confirm the acid has been completely rinsed from the bags, capture some water from the waste tube and check the water with litmus paper.

28. Remove the bags from the oven and place them directly in a Desiccant Pouch. Flatten the pouch to remove ambient air and zip it tight.



IMPORTANT: Do NOT use conventional countertop or cabinet desiccators for this analysis.

29. Allow the bags to cool to room temperature. This should take about 10 - 15 minutes.
30. Remove one filter bag from the Desiccant Pouch. Flatten the pouch to remove ambient air.

IMPORTANT: To prevent moisture from settling on the filter bags, it is important to keep ambient air out of the Desiccant Pouch while weighing the bags. This can be done by holding the pouch flat or zipping it shut after removing filter bags. Zipping the bags too often can reduce the life of the Desiccant Pouch.

31. Re-weigh the filter bag (W_3) immediately.
32. Repeat steps 30 and 31 for each filter bag in the Desiccant Pouch.

33. Calculate ADF using the following formula.

$$\% \text{ ADF (as-received basis)} = \frac{100 \times (W_3 - (W_1 \times C_1))}{W_2}$$

Where:

- W_1 = Bag tare weight
- W_2 = Sample weight
- W_3 = Dried weight of filter bag with fiber after extraction process
- C_1 = Blank bag correction (running average of final oven-dried weight divided by original blank bag weight)

NOTE:

If following the acid detergent procedure with an acid detergent lignin, the procedure can be found on our website at www.ankom.com.

This page intentionally left blank

NDF Analysis

NDF Calculation

NDF contained within a food or feed sample can be calculated using the following formula:

% NDF (as-received basis)	=	$\frac{100 \times (W_3 - (W_1 \times C_1))}{W_2}$
Where:		
	W_1	= Bag tare weight
	W_2	= Sample weight
	W_3	= Dried weight of filter bag with fiber after extraction process
	C_1	= Blank bag correction (running average of final oven-dried weight divided by original blank bag weight)

NDF Sample Preparation Procedure

To prepare samples for fiber analysis, follow the procedure detailed below.

IMPORTANT: When using the ANKOM²⁰⁰ Fiber Analyzer for NDF analysis, at least one blank filter bag should be included with the sample set as an indicator of particle loss. A running average of the blank bag weights is used in the fiber calculation as the C_1 correction factor. A C_1 value larger than 1.0000 indicates that sample particles were lost from filter bags and deposited on the blank bag(s). Any fiber particle loss from the filter bags will generate erroneous results. If particle loss is observed, the grinding method should be evaluated.

- Using a Solvent Resistant Marker, number all of the filter bags you will use during the fiber analysis. Allow the marker to dry on the filter bags.
- Weigh and record the weight of each empty filter bag (W_1).
- Set the Heat Sealer dial to between 4 and 5. (The setting may vary from sealer to sealer.)
- Seal at least one empty filter bag (to be used as a blank) within 4mm of its open end. Keep the sealer arm down for 2 – 3 seconds after the red sealer light turns off (to cool the seal). The seal can be seen as a solid melted stripe along the top edge of the filter bag (as shown to the right). If the seal is not strong, re-seal the bag.
- Place an empty filter bag in the Bag Holder in an open position.
- Tare the weight of the empty filter bag and the holder together.
- Add 0.45 – 0.50g of sample to the filter bag. Keep all particles away from the sealing area of the filter bag.
- Record the weight of the sample (W_2).

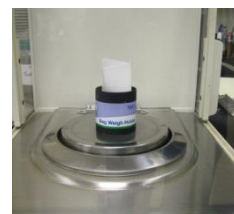

9. Seal the filter bag within 4mm of its open end. Keep the sealer arm down for 2 – 3 seconds after the red sealer light turns off (to cool the seal). The seal can be seen as a solid melted stripe along the top edge of the filter bag. If the seal is not strong, re-seal the bag.
10. To eliminate sample clumping, spread the sample out uniformly within the filter bag by shaking and flicking the bag.
11. Repeat steps 5 – 10 for all filter bags that will be used in the Analyzer. (Up to 24 bags can be processed during one procedure with one of the bags being a blank.)
12. Follow these pre-extraction steps for specified samples.
 - a. **If your samples contain non-roasted soybean or >5% fat:**
Before doing the ADF analysis in the ANKOM^{DELTA}, you will need to do a pre-extraction. For samples containing non-roasted soybean or >5% fat, follow the pre-extraction steps below:
 - 12.1.1 Place the filter bags with sample (up to 23) into a container with a top.
 - 12.1.2 Pour enough fresh acetone into the container to cover the bags.
 - 12.1.3 Put the top on the container.
 - 12.1.4 Allow bags to soak for 10 minutes.
 - 12.1.5 Pour out and dispose of the acetone.
 - 12.1.6 Execute steps 1 through 5 a total of two times.
 - 12.1.7 Place the bags on a wire screen to air-dry.
 - b. **If your samples contain roasted soybean:**
Before doing the ADF analysis in the ANKOM^{DELTA}, you will need to do a pre-extraction. For samples containing roasted soybean, follow the pre-extraction steps below:
 - 12.2.1 Place the filter bags with sample (up to 23) into a container with a top.
 - 12.2.2 Put the top on the container.
 - 12.2.3 Shake the container 10 times.
 - 12.2.4 Allow the samples to soak for twelve hours.
 - 12.2.5 Pour out the acetone.

Place the bags on a wire screen to air-dry.

13. If the sample has settled to the bottom of the bag, spread the sample uniformly inside the filter bags by shaking and flicking the bags to eliminate clumping.
14. Place the filter bags with sample and at least one empty bag (used as a Blank) into the Bag Suspender trays as shown (maximum of three bags per tray).
15. Stack each tray on the Bag Suspender rod (eight trays in total) with each tray rotated 120 degrees from the tray below.



IMPORTANT: You must use all eight trays even if they are empty.

16. Add the 9th tray to the top of the Bag Suspender rod. This tray contains no filter bags and acts as a cover.

NOTE: The samples are now ready for the NDF analysis procedure.

NDF Analysis Procedure using the ANKOM²⁰⁰ Fiber Analyzer

To perform NDF analysis on prepared samples, follow the procedure detailed below.

IMPORTANT: The Vessel must be at room temperature before beginning an NDF analysis.

1. Verify that the Exhaust Hose is connected to the instrument and securely positioned in the drain.
2. Turn the instrument Power Switch to the ON position.
3. Lift the Lid Handle to open the Vessel Lid.
4. Place the Bag Suspender with the samples and the Bag Suspender Weight into the Vessel.
5. Pour a maximum of 2 L of Neutral Detergent (ND) solution into the Vessel along with 20 g of sodium sulfite (0.5 g / 50 ml of ND solution) and 4.0 ml of α -amylase.
6. Press the **HEAT** and **AGITATE** buttons on the front of the instrument so they are lit. Look in the Vessel to confirm agitation.
7. Close the Vessel Lid.
8. On the Timer/Clock, set the Timer to 75 minutes and press the Start/Stop button.
9. When the Timer sounds, the extraction process is complete. Press the **HEAT** and **AGITATE** buttons to turn them off (the buttons will not be lit when they are off). Open the Exhaust Valve (slowly at first) and exhaust the hot solution BEFORE opening the Vessel Lid.

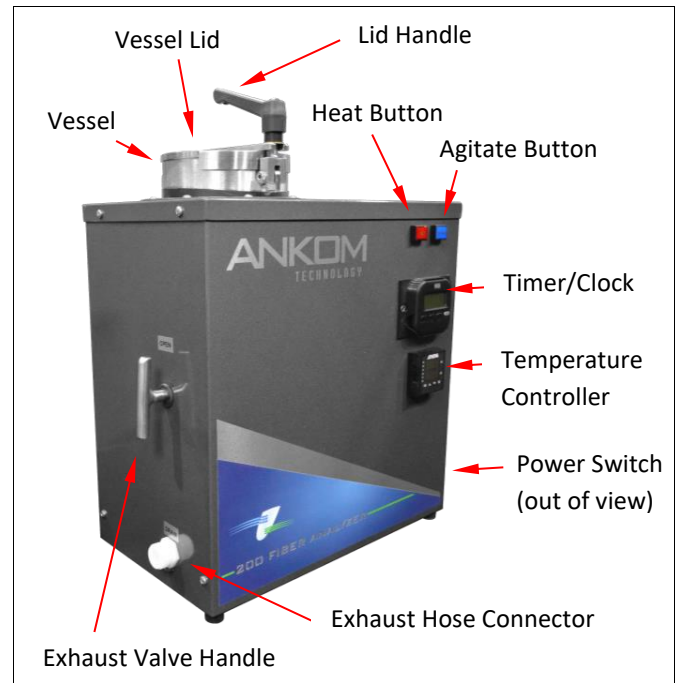

IMPORTANT: Because the Vessel is under pressure, the Exhaust Valve must be opened to release the pressure and the solution BEFORE opening the Vessel Lid.

10. After the solution has been exhausted, open the Vessel Lid slowly to allow air to push any remaining liquid out the Exhaust Hose.
11. Close the Exhaust Valve.
12. Add 1900 ml - 2000 ml of 70°C - 90°C rinse water and 4.0 ml of α -amylase.

IMPORTANT: During the rinse process, if the **HEAT** button is OFF, the Vessel Lid can be open. If the **HEAT** button is ON, the Vessel Lid must be closed.

13. Press the **AGITATE** button.
14. On the Timer/Clock, set the Timer to 5 minutes and press the Start/Stop button.
15. When the Timer sounds, the rinse is complete. Slowly open the Exhaust Valve to drain the hot water.
16. Repeat steps 12 - 16 to accomplish the second rinse.
17. Repeat steps 12 - 16 without adding α -amylase to accomplish the third rinse.
18. After the third rinse, open the Vessel Lid and remove the Bag Suspender from the Vessel.
19. Remove the bags from the Bag Suspender trays and place them in an appropriately sized beaker.

20. With your hands, gently press out excess water from the bags into the beaker and pour off the water from the beaker.
21. With the bags in a beaker, add enough acetone to cover them. Let the bags soak in acetone for 3 - 5 minutes. Pour off the acetone.
22. With your hands, gently press out excess acetone from the bags into the beaker and pour off the acetone from the beaker.
23. Remove the bags from the beaker and place them on a wire screen to air-dry.



Hazardous Materials – Do NOT place bags in an oven until all acetone in the bags has evaporated.

24. Place air-dried bags in the oven and heat at $102^{\circ}\text{C} \pm 2^{\circ}$ for 2 - 4 hours (depending on the oven).

IMPORTANT: When running a lignin procedure or a sequential (NDF/ADF or NDF/ADF/Lignin) with the F57 Filter Bag it is important not to dry the bags overnight after the NDF or ADF procedure. A drying timeframe of 2-4 hours at 100°C to 105°C is sufficient to thoroughly dry the bags after each procedure. Extended drying times or too high a temperature can compromise the bag's filtration media. In addition, after the fourth rinse during the ADF procedure if you would like to confirm the acid has been completely rinsed from the bags, capture some water from the waste tube and check the water with litmus paper.

25. Remove the bags from the oven and place them directly in a Desiccant Pouch. Flatten the pouch to remove ambient air and zip it tight.



IMPORTANT: Do NOT use conventional countertop or cabinet desiccators for this analysis.

26. Allow the bags to cool to room temperature. This should take about 10 - 15 minutes.
27. Remove one filter bag from the Desiccant Pouch. Flatten the pouch to remove ambient air.

IMPORTANT: To prevent moisture from settling on the filter bags, it is important to keep ambient air out of the Desiccant Pouch while weighing the bags. This can be done by holding the pouch flat or zipping it shut after removing filter bags. Zipping the bags too often can reduce the life of the Desiccant Pouch.

28. Re-weigh the filter bag (W_3) immediately.
29. Repeat steps 27 and 28 for each filter bag in the Desiccant Pouch.
30. Calculate NDF using the following formula.

$$\% \text{ NDF (as-received basis)} = \frac{100 \times (W_3 - (W_1 \times C_1))}{W_2}$$

Where:

W_1	=	Bag tare weight
W_2	=	Sample weight
W_3	=	Dried weight of filter bag with fiber after extraction process
C_1	=	Blank bag correction (running average of final oven-dried weight divided by original blank bag weight)

Crude Fiber Analysis

Crude Fiber Calculation

Crude Fiber contained within a food or feed sample can be calculated using the following formula:

% Crude Fiber	=	$\frac{100 \times (W_3 - (W_1 \times C_1))}{W_2}$
Where:	W ₁	= Bag tare weight
	W ₂	= Sample weight
	W ₃	= Weight of Organic Matter (loss of weight on ignition of bag and fiber)
	C ₁	= Ash corrected blank bag factor (running average of loss of weight on ignition of blank bag / original blank bag)

Crude Fiber Sample Preparation Procedure

To prepare samples for fiber analysis, follow the procedure detailed below.

IMPORTANT: When using the ANKOM²⁰⁰ Fiber Analyzer for Crude Fiber analysis, at least one blank filter bag should be included with the sample set as an indicator of particle loss. A running average of the blank bag weights is used in the fiber calculation as the C₁ correction factor. A C₁ value larger than 1.0000 indicates that sample particles were lost from filter bags and deposited on the blank bag(s). Any fiber particle loss from the filter bags will generate erroneous results. If particle loss is observed, the grinding method should be evaluated.

- Using a Solvent Resistant Marker, number all of the filter bags you will use during the fiber analysis. Allow the marker to dry on the filter bags.
- Weigh and record the weight of each empty filter bag (W₁).
- Set the Heat Sealer dial to between 4 and 5. (The setting may vary from sealer to sealer.)
- Seal at least one empty filter bag (to be used as a blank) within 4mm of its open end. Keep the sealer arm down for 2 – 3 seconds after the red sealer light turns off (to cool the seal). The seal can be seen as a solid melted stripe along the top edge of the filter bag (as shown to the right). If the seal is not strong, re-seal the bag.
- Place an empty filter bag in the Bag Holder in an open position.
- Tare the weight of the empty filter bag and the holder together.
- Add 0.95 – 1.00g of sample to the filter bag. Keep all particles away from the sealing area of the filter bag.
- Record the weight of the sample (W₂).

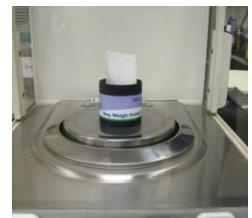
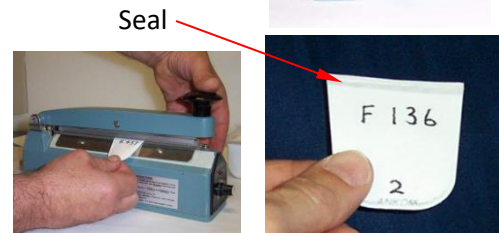

9. Seal the filter bag within 4mm of its open end. Keep the sealer arm down for 2 – 3 seconds after the red sealer light turns off (to cool the seal). The seal can be seen as a solid melted stripe along the top edge of the filter bag. If the seal is not strong, re-seal the bag.
10. To eliminate sample clumping, spread the sample out uniformly within the filter bag by shaking and flicking the bag.
11. Repeat steps 5 – 10 for all filter bags that will be used in the Analyzer. (Up to 24 bags can be processed during one procedure with one of the bags being a blank.)

12. **For all samples you will need to do a pre-extraction of fat.**

Before doing a Crude Fiber analysis in the ANKOM^{DELTA}, follow the pre-extraction steps below:

- 12.1 Place the filter bags with sample into an appropriately sized container.
 - 12.2 Pour enough petroleum ether into the container to cover the bags.
 - 12.3 Put the top on the container.
 - 12.4 Allow the bags to soak for 10 minutes.
 - 12.5 Pour out and dispose of the petroleum ether.
 - 12.6 Place the bags on a wire screen to air-dry.
13. If the sample has settled to the bottom of the bag, spread the sample uniformly inside the filter bags by shaking and flicking the bags to eliminate clumping.
 14. Place the filter bags with sample and at least one empty bag (used as a Blank) into the Bag Suspender trays as shown (maximum of three bags per tray).
 15. Stack each tray on the Bag Suspender rod (eight trays in total) with each tray rotated 120 degrees from the tray below.



IMPORTANT: You must use all eight trays even if they are empty.

16. Add the ninth tray to the top of the Bag Suspender rod. This tray contains no filter bags and acts as a cover.

NOTE: The samples are now ready for the Crude Fiber analysis procedure.

Crude Fiber Analysis Procedure using the ANKOM²⁰⁰ Fiber Analyzer

To perform Crude Fiber analysis on prepared samples, follow the procedure detailed below.

IMPORTANT: The Vessel must be at room temperature before beginning a Crude Fiber analysis.

1. Verify that the exhaust hose is connected to the instrument and securely positioned in the drain.
2. Turn the instrument Power Switch to the ON position.
3. Lift the Lid Handle to open the Vessel Lid.
4. If the temperature on the Temperature Controller display is higher than room temperature, fill the Vessel with cold tap water. The temperature on the display will decrease. When the value on the display reaches its lowest number and starts to increase, open the Exhaust Valve and exhaust the water. Repeat this process until the number on the Temperature Controller equilibrates to room temperature.
5. Place the Bag Suspender with the samples and the Bag Suspender Weight into the Vessel.
6. Pour a maximum of 2 L of ambient temperature acid (0.255N H₂SO₄) solution into the Vessel.
7. Press the **HEAT** and **AGITATE** buttons on the front of the instrument so they are lit. Look in the Vessel to confirm agitation.
8. Close the Vessel Lid.
9. On the Timer/Clock, set the Timer to 40 minutes and press the Start/Stop button.
10. When the Timer sounds, the digestion process is complete. Press the **HEAT** and **AGITATE** buttons to turn them off (the buttons will not be lit when they are off). Open the Exhaust Valve (slowly at first) and exhaust the hot solution BEFORE opening the Vessel Lid.

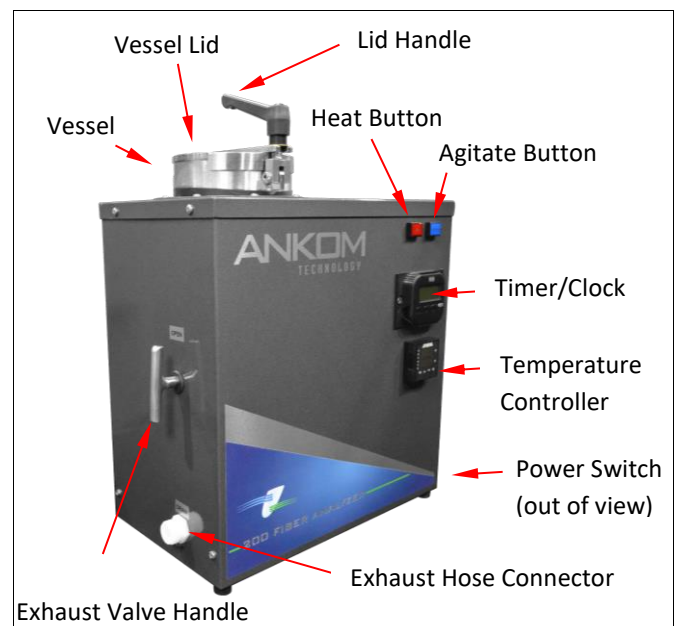

IMPORTANT: Because the Vessel is under pressure, the Exhaust Valve must be opened to release the pressure and the solution BEFORE opening the Vessel Lid.

11. After the solution has been exhausted, open the Vessel Lid slowly to allow air to push any remaining liquid out the Exhaust Hose
12. Close the Exhaust Valve.
13. Add 1900 ml - 2000 ml of 50°C - 90°C rinse water.

IMPORTANT: During the rinse process, if the **HEAT** button is OFF, the Vessel Lid can be open. If the **HEAT** button is ON, the Vessel Lid must be closed.

14. Press the **AGITATE** button.
15. On the Timer/Clock, set the Timer to 5 minutes and press the Start/Stop button.
16. When the Timer sounds, the rinse is complete. Slowly open the Exhaust Valve to drain the hot water.
17. Repeat steps 12 - 16 to accomplish the second rinse.
18. Add 1900 ml - 2000 ml of ambient temperature base (0.313N NaOH) solution.

19. Press the **HEAT** and **AGITATE** buttons on the front of the instrument so they are lit. Look in the Vessel to confirm agitation.
20. Close the Vessel Lid.
21. On the Timer/Clock, set the Timer to 40 minutes and press the Start/Stop button.
22. When the Timer sounds, the extraction is complete. Press the **HEAT** and **AGITATE** buttons to turn them off (the buttons will not be lit when they are off). Open the Exhaust Valve (slowly at first) and exhaust the hot solution **BEFORE** opening the Vessel Lid.

IMPORTANT: Because the Vessel is under pressure, the Exhaust Valve must be opened to release the pressure and the solution **BEFORE** opening the Vessel Lid.

23. After the solution has been exhausted, open the Vessel Lid slowly to allow air to push any remaining liquid out the Exhaust Hose.
24. Close the Exhaust Valve.
25. Add 1900 ml - 2000 ml of 50°C - 90°C rinse water.

IMPORTANT: During the rinse process, if the **HEAT** button is OFF, the Vessel Lid can be open. If the **HEAT** button is ON, the Vessel Lid must be closed.

26. Press the **AGITATE** button.
27. On the Timer/Clock, set the Timer to 5 minutes and press the Start/Stop button.
28. When the Timer sounds, the rinse is complete. Slowly open the Exhaust Valve to drain the hot water.
29. Repeat steps 24 - 28 two times (total of three rinses).
30. After the third rinse, open the Vessel Lid and remove the Bag Suspender from the Vessel.
31. Remove the bags from the Bag Suspender trays and place them in an appropriately sized beaker.
32. With your hands, gently press out excess water from the bags into the beaker and pour off the water from the beaker.
33. With the bags in a beaker, add enough acetone to cover them. Let the bags soak in acetone for 3 - 5 minutes. Pour off the acetone.
34. With your hands, gently press out excess acetone from the bags into the beaker and pour off the acetone from the beaker.
35. Remove the bags from the beaker and place them on a wire screen to air-dry.



Hazardous Materials – Do NOT place bags in an oven until all acetone in the bags has evaporated.

36. Place air-dried bags in the oven and heat at 102°C ± 2° for 2 - 4 hours (depending on the oven).
37. Remove the bags from the oven and place them directly in a Desiccant Pouch. Flatten the pouch to remove ambient air and zip it tight.



IMPORTANT: Do NOT use conventional countertop or cabinet desiccators for this analysis.

38. Allow the bags to cool to room temperature. This should take about 10 - 15 minutes.

39. Remove one filter bag from the Desiccant Pouch. Flatten the pouch to remove ambient air.

IMPORTANT:

To prevent moisture from settling on the filter bags, it is important to keep ambient air out of the Desiccant Pouch while weighing the bags. This can be done by holding the pouch flat or zipping it shut after removing filter bags. Zipping the bags too often can reduce the life of the Desiccant Pouch.

40. Re-weigh the filter bag (W_3) immediately.
41. Repeat steps 39 and 40 for each filter bag in the Desiccant Pouch.
42. Ash all filter bags in pre-weighed crucibles for 2 hours at $600^{\circ}\text{C} \pm 15^{\circ}$.
43. Cool the ashed crucibles in a conventional desiccator.
44. Weigh the ashed crucibles to calculate the loss of weight of organic matter (W_3).
45. Calculate Crude Fiber using the following formula.

% Crude Fiber	=	$\frac{100 \times (W_3 - (W_1 \times C_1))}{W_2}$
Where:		
	W_1	= Bag tare weight
	W_2	= Sample weight
	W_3	= Weight of Organic Matter (loss of weight on ignition of bag and fiber)
	C_1	= Ash corrected blank bag factor (running average of loss of weight on ignition of blank bag / original blank bag)

This page intentionally left blank

Periodic Maintenance

Initial Maintenance after the first 10 hours of operation, and then periodic maintenance after every 80 hours of operation.

Follow the procedure below:

1. After every 3 hours of use check the Maintenance Alert Reservoir for any fluid accumulation.
2. If any fluid is present, unscrew the Reservoir bottle and empty the fluid.
3. Screw the Reservoir into the instrument.

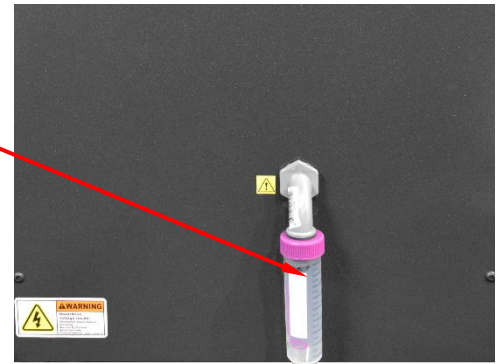

Rear View

Maintenance Alert Collector

Packing Nut

4. Turn the instrument off and disconnect the power cord from the power source.
5. Remove the back panel of the instrument.
6. Visually inspect the area between the Packing Nut and the Maintenance Alert Collector.
7. If leakage has occurred, clean the area thoroughly.
8. Reconnect the instrument power cord to the power source and turn the instrument on.

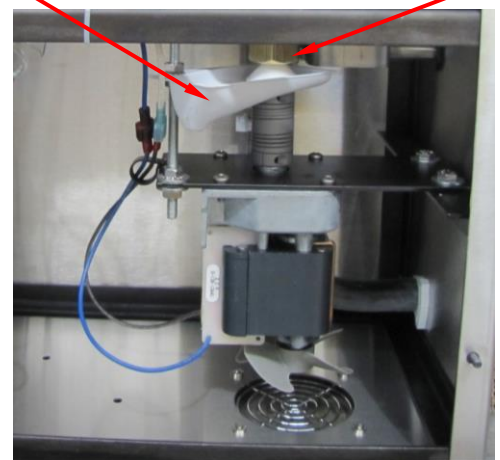

Rear View with cabinet removed

9. Press the **AGITATE** button on the front of the instrument so it is lit. This will turn the agitator motor on.
10. With the motor activated, turn the Packing Nut to the **RIGHT** until you hear a change in the sound of the motor. (The motor will start to labor as the packing nut gets harder to turn.)
11. Loosen the Packing Nut slightly until the motor stops laboring.
12. Turn off the instrument and re-install the back panel.
13. Check the Maintenance Alert Reservoir after the next assay.

After every 80 hours of operation, repeat the Initial Maintenance procedure (all 13 steps above), whether you see leaks or not.

If you see a leak

If you see a leak, execute the Initial Maintenance procedure above, loosening the Packing Nut 1/16 of a turn. If the leak continues, replace the packing and agitator.

Replacing the Fuse in a 120V instrument

To replace the fuse in a 120V ANKOM²⁰⁰ Fiber Analyzer, follow the procedure detailed below.

1. Turn off the instrument power and unplug the Power Cord from the outlet.
2. Using a flat blade screwdriver, twist the slot on the fuse holders clockwise ¼ turn to open.
3. Replace the 15 amp glass or ceramic fuse.
4. Install the fuse in the fuse holder.
5. Re-install the fuse holder into the instrument.



Fuse

Reset/replace the Circuit Breaker in a 220V instrument

To reset/replace the circuit breaker in a 220V ANKOM²⁰⁰ Fiber Analyzer, follow the procedure detailed below.

1. Turn off the instrument power and unplug the Power Cord from the outlet.
2. Push the re-settable circuit breaker in.
3. If the breaker will not reset, then replace it.

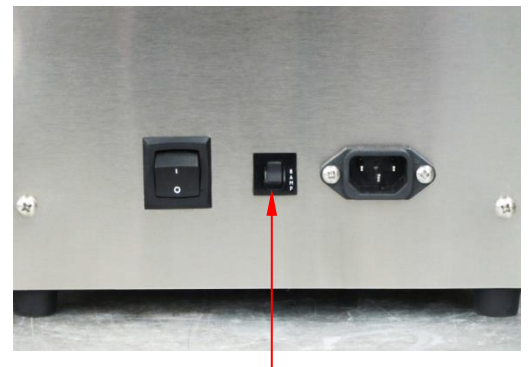

Re-settable
Circuit Breaker

Cleaning the exterior of the instrument

Acid residue left on the exterior of the instrument can damage external electrical components. To clean the exterior of the instrument, wipe the outside cabinet with a retail window cleaner.

Check the Agitation System

The agitation system should be checked every three to six months or if fiber values are higher than normal or inconsistent. To check the Agitation System, follow the procedure detailed below.

IMPORTANT: Poor agitation will cause higher analysis values and poor repeatability.

1. Check the function of the agitator motor.

- 1.1 Place a full bag suspender in the Vessel along with the bag suspender weight, but add NO water.
- 1.2 Press the **AGITATE** button so that it is lit.
- 1.3 Verify that the bag suspender moves up 16 times in 15 seconds (65 rpm).

2. Measure the stroke of the agitation system.

- 2.1 Place a full bag suspender (without the bag suspender weight) in the empty Vessel.
- 2.2 Remove the top from a dark felt tip marker.
- 2.3 Lay the marker horizontally on the top of the bag suspender so that the tip touches the inside wall of the Vessel.
- 2.4 With constant light downward pressure on the marker, hold the pen in place so that it rides the top tray up and down once the agitation has begun.
- 2.5 Turn the instrument Power Switch to the ON position.
- 2.6 Press the **AGITATE** button so that it is lit.
- 2.7 Allow the bag suspender (& pen) to move up and down three or four times as the pen marks the Vessel wall.
- 2.8 Press the **AGITATE** button so that it is NOT lit. This will turn the agitation off.
- 2.9 Turn the instrument Power Switch to the OFF position.
- 2.10 Remove the pen and the Bag Suspender.
- 2.11 Measure the mark on the Vessel wall. It should be $\frac{1}{2}$ inch long. If the motion is less than $\frac{1}{2}$ inch, you will need to replace either the Bag Suspender Tip (see next page) or the agitator (because the old disc has flattened).



3. Check the tip for excessive wear.

Replace worn tips (see pictures).

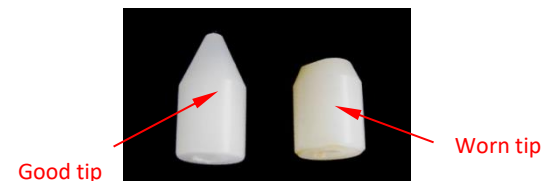

Check the Temperature Control using the Boil Test

To check the ANKOM²⁰⁰ Fiber Analyzer temperature control, do a Boil Test *once per month* as specified in the procedure below.

1. Turn on the instrument.
2. On the Instrument Controller, ensure that Display 1 shows the current ambient temperature and Display 2 shows 100.0.
3. Open the Vessel Lid.
4. Place approximately 1800ml of room temperature water (about 20°C) in the empty ANKOM²⁰⁰ digestion vessel, leaving the Bag Suspender out of the Vessel.
5. Press the red **HEAT** and blue **AGITATE** buttons on the front of the instrument so that they are lit.
6. Occasionally stir the water to maintain uniform heating.

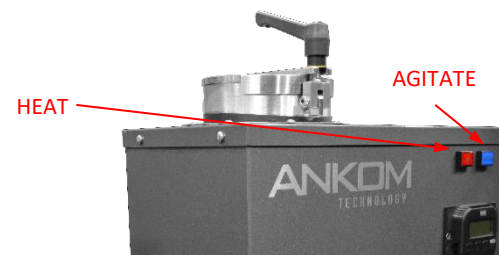

7. With water in the Vessel, place a calibrated thermometer in the bottom of the Vessel near the probe without the thermometer touching the Vessel.



8. Record the readings on the thermometer and on Display 1. Repeat two additional times during the heat-up.
9. Record the amount of time it takes to reach the initial boil and the temperature on Display 1 when a strong boil is reached.
10. Five minutes after reaching the initial boil, stir the water and record the temperature.







Reading #	Thermometer (°C)	Display 1 (°C)
1		
2		
3		

Time to Boil (minutes)	Display 1 (°C)

Display 1 (°C)

If a boil does NOT occur within 15 minutes, or if the temperature readings on the calibrated thermometer do NOT read the same as the temperatures shown on Display 1 of the controller, follow the Controller Temperature Calibration procedure on the following page to adjust the calibration.

Controller Temperature Calibration

1. Fill the instrument with 2 liters of tap water.
2. Press the red **HEAT** and blue **AGITATE** buttons on the front of the instrument so that they are lit.
3. Bring the water to a boil.
4. Press  on the controller until you see **Ac.Cd.**
5. Press  on the controller until you see **Ac.04** on Display 2.
6. Press  on the controller until you see **CAL.H** on Display 2.
7. Stir the water vigorously.
8. Place a calibrated thermometer in the bottom of the Vessel near the probe without the thermometer touching the Vessel. This will be your reference temperature.
9. Press  on the controller to set Display 2 to the temperature on the calibrated thermometer.
10. Press  on the controller until you see **Ac.Cd** on Display 2.
11. Press  on the controller until you see **Ac.01** on Display 2.
12. Press  on the controller to save the calibration.

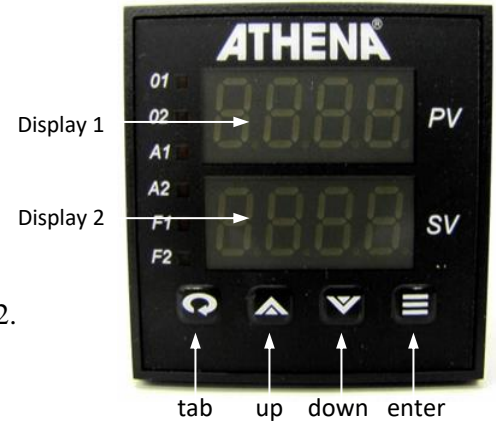

The ANKOM²⁰⁰ controller is now calibrated. The instrument will boil water at the calibrated temperature and maintain the proper temperature throughout an assay.

Check the Bag Suspender

The Bag Suspender should be checked every three to six months or if fiber values are higher than normal or inconsistent. To check the Bag Suspender, follow the procedure detailed below.

1. Verify that you are using the **NEW** version of the Bag Suspender Trays.

The NEW version of the trays has 9 holes in groups of 3 as shown in the picture to the right.



IMPORTANT: You CANNOT use the new and old bag suspender trays together.

2. Check the trays for melting.

The pictures shown are examples of extreme cases. However, for proper operation you must replace trays that show signs of melting or wear.

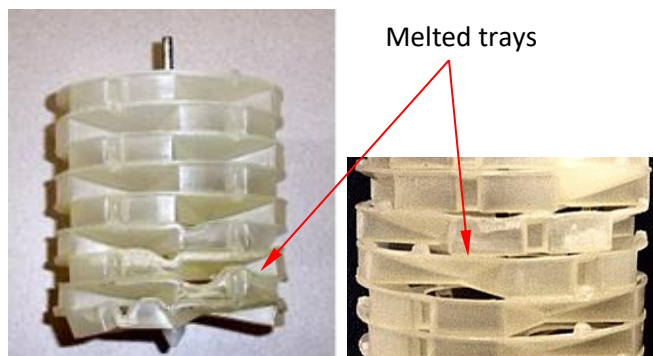

3. Check that the bottom tray is flat.

If the bottom tray is concave (see picture) the bag suspender will catch in the vessel and melt.



Storage

Acid residue can corrode the instrument if left on or in the instrument. Before storing the instrument (or leaving the instrument unused) for greater than one month, rinse the Vessel thoroughly with water using the following procedure.

1. Fill the Vessel with water.
2. Press the **AGITATE** button so that it is lit.
3. After 10 minutes, press the **AGITATE** button so that it is NOT lit. This will turn the agitation off.
4. Open the Exhaust Valve and exhaust the hot water.
5. After the water has been exhausted, close the Exhaust Valve.

Troubleshooting & Replacement Parts

The ANKOM technology web site has the most current troubleshooting and replacement parts information. Therefore, if you have any questions about the operation of your ANKOM²⁰⁰ Fiber Analyzer, or if you need replacement parts, please visit our web site at www.ankom.com.

Appendix A- Analytical Procedures

IMPORTANT:

While infrequent, procedures may be updated with new information. For the most up-to-date procedure revision refer to: <https://www.ankom.com/analytical-methods-support/fiber-analyzer-a200>.

Acid Detergent Fiber in Feeds - Filter Bag Technique (for A200 and A200I)

Definition

This method determines Acid Detergent Fiber, which is the residue remaining after digesting with H₂SO₄ and CTAB. The fiber residues are predominantly cellulose and lignin.

Scope

This method is applicable to grains, feeds, forages, and all fiber-bearing material.

Apparatus

1. Analytical Balance—capable of weighing 0.1 mg.
2. Oven—capable of maintaining a temperature of 102 ± 2°C.
3. Digestion instrument—capable of performing the digestion at 100 ± 0.5°C and maintaining a pressure of 10-25 psi. The instrument must be capable of creating a similar flow around each sample to ensure uniformity of extraction (ANKOM²⁰⁰ with 65 rpm agitation, ANKOM Technology).
4. Filter Bags—constructed from chemically inert and heat resistant filter media, capable of being heat sealed closed and able to retain 25-micron particles while permitting rapid solution penetration (F57 and F58, ANKOM Technology).
5. Heat sealer—sufficient for sealing the filter bags closed to ensure complete closure (HS or HSi, ANKOM Technology).
6. Desiccant Pouch—collapsible sealable pouch with desiccant inside that enables the removal of air from around the filter bags (*MoistureStop* weigh pouch, ANKOM Technology).
7. Marking pen—solvent and acid resistant (F08, ANKOM Technology).

Reagents

1. Acid Detergent Solution—Add 20g cetyl trimethylammonium bromide (CTAB) to 1L 1.00N H₂SO₄ previously standardized (premixed chemical solution available from ANKOM). Agitate and heat to aid solution.
CAUTION1: Sulfuric acid is a strong acid and will cause severe burns. Protective clothing should be worn when working with this acid. Always add acid to water and not the reverse.
CAUTION2: CTAB will irritate mucous membranes. A dust mask and gloves should be worn when handling this chemical.

Sample Preparation

Grind samples in a centrifugal mill with a 2mm screen or cutter type (Wiley) mill with a 1mm screen. Samples ground finer may have particle loss from the filter bags and result in low values.

ADF Procedure (see the ADF Analysis section of the Operator's Manual for more detail)

1. Use a solvent resistant marker to label the filter bags to be used in the analysis.
2. Weigh and record the weight of each empty filter bag (W₁) and zero the balance. NOTE: Do not pre-dry filter bags. Any moisture will be accounted for by the blank bag correction.
3. Place 0.5g (±0.05g) of prepared sample in up to 23 of the bags and record the weight (W₂) of each. Avoid placing the sample in the upper 4mm of the bag.
4. Include at least one empty bag in the run to determine the blank bag correction (C₁).
 NOTE: A running average blank bag correction factor (C₁) should be used in the calculation of fiber. The inclusion of at least one blank bag in each run is mainly used as an indicator of particle loss. A C₁ larger than 1.0000 indicates that sample particles were lost from filter bags and deposited on the blank bag during the extraction. Any fiber particle loss from the filter bags will generate erroneous results. If particle loss is observed, then the grinding method needs to be evaluated.
5. Using a heat sealer, completely seal each filter bag closed within 4mm of the top to encapsulate the sample. NOTE: Use sufficient heat to completely seal the filter bags and allow enough cool time (2 sec) before raising the heat sealer arm to remove each bag from the heat sealer.
6. Spread the sample uniformly inside the filter bags by shaking and flicking the bags to eliminate clumping.
7. **Pre-extract only samples containing >5% fat:** Extract samples by placing bags with samples into a container with a top. Pour enough acetone into the container to cover the bags and secure the top.
CAUTION3: Acetone is extremely flammable. Avoid static electricity and use a fume hood when handling. Allow the bags to soak for 10 minutes. Repeat with fresh acetone. Pour out acetone and place bags on a wire screen to air-dry.
Exception – Roasted soybean: Due to the processing of roasted soy a modification to the extraction is required. Place roasted soy samples into a container with a top. Pour enough acetone into the container to cover the bags and secure the top. Shake the container 10 times and pour off the acetone. Add fresh acetone and allow samples to soak for **twelve hours**. After the soak time, pour out the acetone and place the bags on a wire screen to air-dry.
8. Spread the sample uniformly inside the filter bags by shaking and flicking the bags to eliminate clumping.
9. Place up to 3 bags on each of eight Bag Suspender Trays (maximum of 24 bags). Stack the trays on the center post of the Bag Suspender with each level rotated 120 degrees in relation to the tray below it. Place the empty 9th tray on top. NOTE: All nine trays must be used regardless of the number of bags being processed.
10. Verify that the Exhaust Hose is connected to the instrument and securely positioned in the drain.
 (Procedure continued on next page.)

Calculations

$$\% \text{ ADF (as-received basis)} = \frac{100 \times (W_3 - (W_1 \times C_1))}{W_2}$$

Where:

- W_1 = Bag tare weight
- W_2 = Sample weight
- W_3 = Dried weight of bag with fiber after extraction process
- C_1 = Blank bag correction (running average of final oven-dried weight divided by original blank bag weight)

ADF Procedure (continued)

11. Turn the instrument Power Switch to the ON position.
12. Before inserting the Bag Suspender into the Vessel, read the Temperature Controller on the instrument. If the temperature is higher than room temperature, fill the Vessel with cold tap water. The temperature on the Controller will decrease. When the value on the Controller reaches its lowest number and starts to increase, open the Exhaust Valve, and exhaust the water. Repeat this process until the number on the Temperature Controller equilibrates to room temperature.
13. Open the Vessel Lid and insert the Bag Suspender with bags into the Vessel and place the Bag Suspender Weight on top of the empty 9th tray to keep the Bag Suspender submerged.
14. When processing 24 sample bags, add 1900-2000 mL of ambient temperature AD solution to the fiber analyzer vessel. If processing less than 20 bags, add 100 mL/bag of AD solution (use minimum of 1500 mL to ensure Bag Suspender is covered).
15. Turn Agitate and Heat ON and confirm agitation.
16. Set the timer for 60 minutes and close the lid.
17. When the ADF extraction is complete, turn Agitate and Heat OFF.
18. Open the drain valve (slowly at first) and exhaust the hot solution before opening the Vessel Lid. NOTE: The solution in the Vessel is under pressure. The exhaust valve needs to be opened to release the pressure and solution prior to opening the Vessel Lid.
19. After the solution has been exhausted, close the exhaust valve and open the Vessel Lid. Add 1900-2000 mL of 70-90°C rinse water. Turn Agitate on and rinse for 5 minutes. If the Heat is ON, the Vessel Lid should be closed. If the Heat is OFF, the Vessel Lid can be open. Repeat 5-minute hot water rinses 2 more times. Just before draining the 3rd rinse, test the water with pH paper. If acid is present repeat rinses until neutral.
20. After the rinsing procedures are complete, open the Vessel Lid and remove the filter bags. Gently press out excess water from the bags. Place bags in a 250ml beaker and add enough acetone to cover the bags and soak for 3-5 minutes.
21. Remove the filter bags from the acetone and place them on a wire screen to air-dry. Completely dry in an oven at 102 ± 2°C. (In most ovens the filter bags will be completely dry within 2-4 hours.) Do not place bags in the oven until the acetone in the bags has completely evaporated.
NOTE: When running a lignin procedure or a sequential (NDF/ADF or NDF/ADF/Lignin) with the F57 Filter Bag it is important not to dry the bags overnight after the NDF or ADF procedure. A drying timeframe of 2-4 hours at 100°C to 105°C is sufficient to thoroughly dry the bags after each procedure. Extended drying times or too high a temperature can compromise the bag's filtration media. In addition, be sure to check the water of the fourth rinse during the ADF procedure to ensure all the sulfuric acid has been removed from the bags. If litmus paper shows the presence of acid during the fourth hot water rinse, repeat until neutral.
22. Remove the filter bags from the oven and immediately place them directly into a collapsible desiccant pouch and flatten to remove any air. Cool to ambient temperature and weigh the filter bags (W_3). NOTE: Do not use a conventional desiccator container.

Neutral Detergent Fiber in Feeds - Filter Bag Technique (for A200 and A200I)

Definition

This method determines Neutral Detergent Fiber, which is the residue remaining after digesting in a detergent solution. The fiber residues are predominantly hemicellulose, cellulose, and lignin.

Scope

This method is applicable to grains, feeds, forages, and all fiber-bearing material.

Apparatus

1. Analytical Balance—capable of weighing 0.1 mg.
2. Oven—capable of maintaining a temperature of $102 \pm 2^\circ\text{C}$.
3. Digestion instrument—capable of performing the digestion at $100 \pm 0.5^\circ\text{C}$ and maintaining a pressure of 10-25 psi. The instrument must be capable of creating a similar flow around each sample to ensure uniformity of extraction (ANKOM²⁰⁰⁰ with 65rpm agitation, ANKOM Technology).
4. Filter Bags—constructed from chemically inert and heat resistant filter media, capable of being heat sealed closed and able to retain 25-micron particles while permitting solution penetration (F57 and F58, ANKOM Technology).
5. Heat sealer—sufficient for sealing the filter bags closed to ensure complete closure (HS or HSi, ANKOM Technology).
6. Desiccant Pouch—collapsible sealable pouch with desiccant inside that enables the removal of air from around the filter bags (*MoistureStop* weigh pouch, ANKOM Technology).
7. Marking pen—solvent and acid resistant (F08, ANKOM Technology).

Reagents

1. Neutral Detergent Solution—Add 30g Sodium lauryl sulfate (USP), 18.61g Ethylenediaminetetraacetic disodium salt (dehydrate), 6.81g Sodium borate, 4.56g Sodium phosphate dibasic (anhydrous), and 10.0ml Triethylene glycol to 1L distilled H₂O (premixed chemical solution available from ANKOM Technology). Check that pH is from 6.9 to 7.1. Agitate and heat to aid solution.
CAUTION1: Powdered chemicals will irritate mucous membranes. A dust mask and gloves should be worn when handling these chemicals.
2. Alpha-amylase—Heat-stable bacterial alpha-amylase: activity = 17,400 Liquefon Units / ml (FAA, ANKOM Technology).
3. Sodium sulfite—Na₂SO₃, anhydrous (FSS, ANKOM Technology)

Sample Preparation

Grind samples in a centrifugal mill with a 2mm screen or cutter type (Wiley) mill with a 1mm screen. Samples ground finer may have particle loss from the filter bags and result in low values.

NDF Procedure (see the NDF Analysis section of the Operator's Manual for more detail)

1. Use a solvent resistant marker to label the filter bags to be used in the analysis.
2. Weigh and record the weight of each empty filter bag (W_1) and zero the balance. NOTE: Do not pre-dry filter bags. Any moisture will be accounted for by the blank bag correction.
3. Place 0.5g (± 0.05 g) of prepared sample in up to 23 of the bags and record the weight (W_2) of each. Avoid placing the sample in the upper 4mm of the bag.
4. Include at least one empty bag in the run to determine the blank bag correction (C_1).
NOTE: A running average blank bag correction factor (C_1) should be used in the calculation of fiber. The inclusion of at least one blank bag in each run is mainly used as an indicator of particle loss. A C_1 larger than 1.0000 indicates that sample particles were lost from filter bags and deposited on the blank bag during the extraction. Any fiber particle loss from the filter bags will generate erroneous results. If particle loss is observed, then the grinding method needs to be evaluated.
5. Using a heat sealer, completely seal each filter bag closed within 4mm of the top to encapsulate the sample. NOTE: Use sufficient heat to completely seal the filter bags and allow enough cool time (2 sec) before raising the heat sealer arm to remove each bag from the heat sealer.
6. Spread the sample uniformly inside the filter bags by shaking and flicking the bags to eliminate clumping.
7. **Pre-extract only samples containing >5% fat:** Extract samples by placing bags with samples into a container with a top. Pour enough acetone into the container to cover the bags and secure the top.
CAUTION2: Acetone is extremely flammable. Avoid static electricity and use a fume hood when handling.
Allow bags to soak for 10 minutes. Repeat with fresh acetone. Pour out acetone and place bags on a wire screen to air-dry.
Exception – Roasted soybean: Due to the processing of roasted soy a modification to the extraction is required. Place roasted soy samples into a container with a top. Pour enough acetone into the container to cover the bags and secure the top. Shake the container 10 times and pour off the acetone. Add fresh acetone and allow samples to soak for twelve hours. After the soak time, pour out the acetone and place the bags on a wire screen to dry.
8. Spread the sample uniformly inside the filter bags by shaking and flicking the bags to eliminate clumping.
9. Place up to 3 bags on each of eight Bag Suspender Trays (maximum of 24 bags). Stack the trays on the center post of the Bag Suspender with each level rotated 120 degrees in relation to the tray below it. Place the empty 9th tray on top. NOTE: All nine trays must be used regardless of the number of bags being processed.
10. Verify that the Exhaust Hose is connected to the instrument and securely positioned in the drain.
11. Turn the instrument Power Switch to the ON position.
12. Open the Vessel Lid and insert the Bag Suspender with bags into the Vessel and place the Bag Suspender weight on top of the empty 9th tray to keep the Bag Suspender submerged.
(Procedure continued on next page.)

Calculations

$$\% \text{ NDF (as-received basis)} = \frac{100 \times (W_3 - (W_1 \times C_1))}{W_2}$$

Where:

- W₁ = Bag tare weight
- W₂ = Sample weight
- W₃ = Dried weight of bag with fiber after extraction process
- C₁ = Blank bag correction (running average of final oven-dried weight divided by original blank bag weight)

NDF Procedure (continued)

13. When processing 24 sample bags, add 1900-2000 mL of ambient temperature ND solution to the fiber analyzer vessel. If processing less than 20 bags, add 100 mL/bag of ND solution (use minimum of 1500 mL to ensure Bag Suspender is covered). Add 20 g (0.5 g per 50 mL of ND solution) of sodium sulfite and 4.0 mL of alpha-amylase to the solution in the vessel.
14. Turn Agitate and Heat ON and confirm agitation.
15. Set the timer for 75 minutes and close the lid.
16. When the NDF extraction is complete, turn Agitate and Heat OFF.
17. Open the drain valve (slowly at first) and exhaust the hot solution before opening the Vessel Lid. NOTE: The solution in the Vessel is under pressure. The exhaust valve needs to be opened to release the pressure and solution prior to opening the Vessel Lid.
18. After the solution has been exhausted, close the exhaust valve and open the Vessel Lid. Add 1900-2000 mL of 70-90°C rinse water and 4.0 mL of alpha-amylase to the first and second rinses. Turn Agitate on and rinse for 5 minutes. If the Heat is ON, the Vessel Lid should be closed. If the Heat is OFF, the Vessel Lid can be open. Repeat 5-minute hot water rinse 1 more time for a total of 3 rinses.
19. When the NDF extraction and rinsing procedures are complete, open the Vessel Lid and remove the filter bags. Gently press out excess water from the bags. Place bags in a 250ml beaker and add enough acetone to cover bags and soak for 3-5 minutes.
20. Remove the filter bags from the acetone and place them on a wire screen to air-dry. Completely dry in an oven at 102 ± 2°C. (In most ovens the filter bags will be completely dry within 2-4 hours.) Do not place bags in the oven until the acetone in the bags has completely evaporated.
NOTE: When running a lignin procedure or a sequential (NDF/ADF or NDF/ADF/Lignin) with the F57 Filter Bag it is important not to dry the bags overnight after the NDF or ADF procedure. A drying timeframe of 2-4 hours at 100°C to 105°C is sufficient to thoroughly dry the bags after each procedure. Extended drying times or too high a temperature can compromise the bag's filtration media. In addition, be sure to check the water of the fourth rinse during the ADF procedure to ensure all the sulfuric acid has been removed from the bags. If litmus paper shows the presence of acid during the fourth hot water rinse, repeat until neutral.
21. Remove the filter bags from the oven and immediately place them directly into a collapsible desiccant pouch and flatten to remove any air. Cool to ambient temperature and weigh the filter bags (W₃). NOTE: Do not use a conventional countertop or cabinet desiccator.

Crude Fiber Analysis in Feeds - Filter Bag Technique (for DELTA, DELTAI, A200, A200I, A2000 and A2000I)

Definition

This method determines Crude Fiber which is the organic residue remaining after digesting with 0.255N H₂SO₄ and 0.313N NaOH. The compounds removed are predominantly protein, sugar, starch, lipids, and portions of both the structural carbohydrates and lignin.

Scope

This method is applicable for all feed materials such as grains, meals, pet foods, mixed feeds, forages, and the following oilseeds: corn and soybeans.

ABSTRACT

AOCS Ba 6a-05 is used for the determination of crude fiber in grains, meals, pet foods, mixed feeds, forages, oilseeds (such as corn and soybeans) and fiber-bearing material from which fat can be extracted to leave workable residue. Crude fiber is the loss on ignition of the dried residue remaining after digestion of the sample in 0.255N H₂SO₄ and 0.313N NaOH solutions under specific conditions. Samples are prepared and ground to a uniform fineness (e.g. Wiley 1mm screen or 2mm cyclone mill). One gram samples are sealed in F57 or F58 filter bags and pre-extracted in a beaker with ether. Up to 24 pre-extracted samples are placed in a bag suspender and inserted into the Fiber Analyzer for processing. The instrument then automatically performs all the necessary procedural steps to digest the samples and rinse them. Samples are then ashed and reported on organic matter basis.

Complete operational details are available in the ANKOM Operator's Manuals.

AOCS Method Ba 6a-05 can be obtained directly from [AOCS](#)

This page intentionally left blank

Appendix B – Wiring Diagram

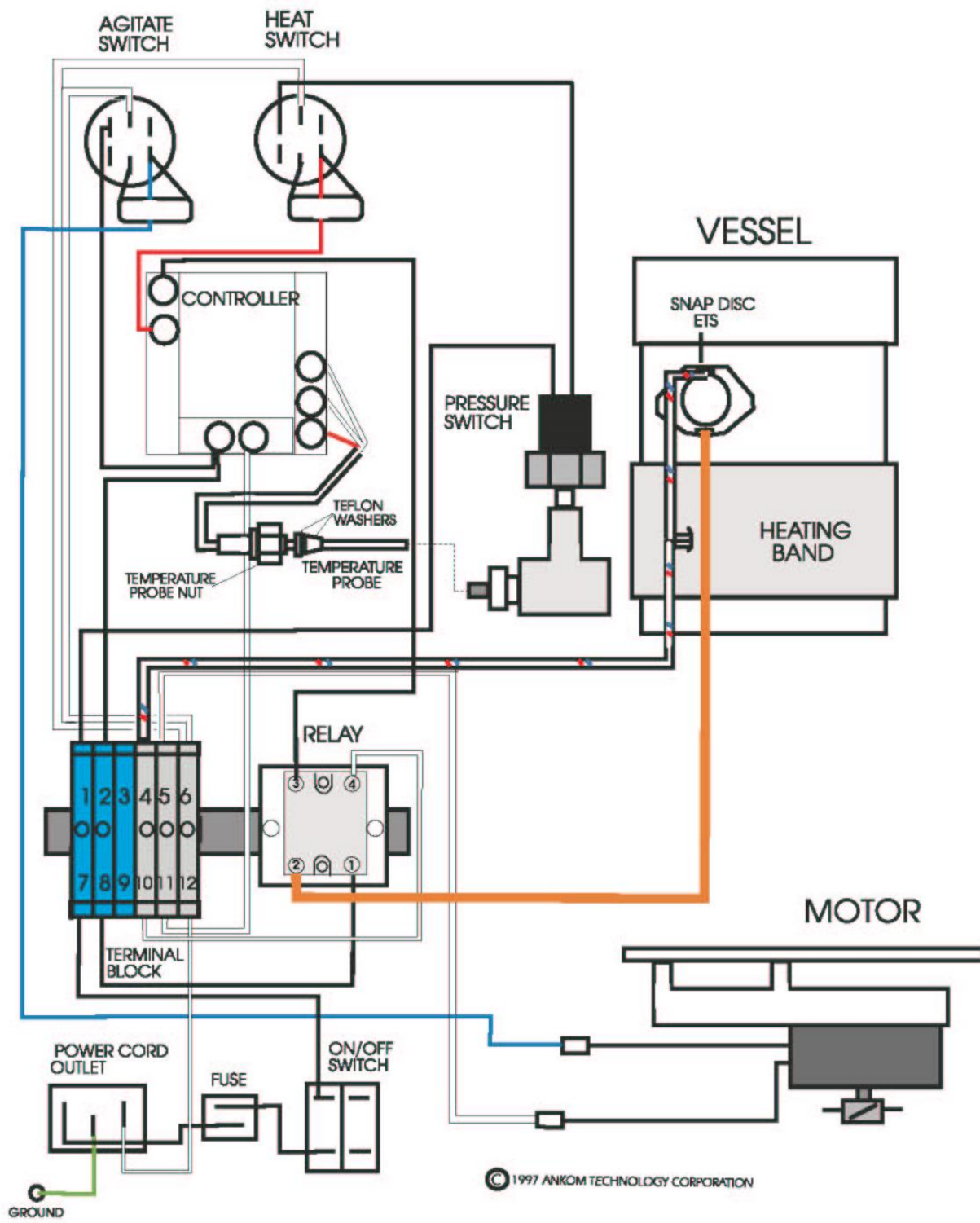

Appendix C- Timer Operating Instruction

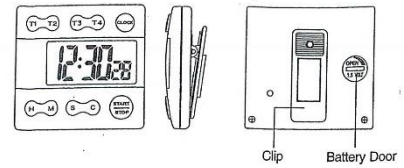

Product Features:

1. Jumbo display 4 channel LCD count-down / count-up timer with clock and alarm features.
2. 6 digit display shows hour, minute and second setting for timers and clock.
3. Automatic count-up after timer counts down to zero.
4. Count-down timer: Maximum setting is 99 hours, 59 minutes, and 59 seconds. Counts down at 1 second resolution. Count-up timer: Maximum count-up range is 99 hours, 59 minutes, and 59 seconds. Counts up at 1 second resolution.
5. Memory recall function for count-down timers.
6. Timer alarm sounds for 1 minute when timer counts down to zero.

Clock Mode:

1. Press the clock button to enter clock mode. Preset time (hours, minutes and seconds) and flashing colon are displayed.
2. Press and hold START/STOP button for 3 seconds to toggle 12/24 hour format.

Clock Setting Mode:

1. Press and hold the clock button for 3 seconds (until beep) to enter time setting mode. "HOUR", "MINUTE", "SECOND" and colon flash on display. The "P" indicator shows in 12 hour format.
2. Press the HOUR button to advance hour setting. Press and hold for 2 seconds for fast setting.
3. Press the MINUTE button to advance minute setting. Press and hold for 2 seconds for fast setting.
4. Press the SECOND button to reset second digit to zero when the second digits are within 00-29 second range. Press S button to reset second digits to zero and minute digits advance by 1 increment when second digit are within 30-59 second range.
5. When the time setting for the clock is ready, press the clock button once to return to normal clock display mode.
**When the timer is running, the corresponding indicator (T1, T2, T3, T4) flashes on display. All four timers can run at the same time. When the timer reaches to 0:00 00, the buzzer will sound and the corresponding indicator (T1, T2, T3, T4) will flash relatively slower. More than one indicator can flash at the same time.

Count Down Timer Setting:

1. Press the T1, T2, T3, or T4 button enter to the desired timer channel. In timer mode, the colon does not flash and the corresponding timer indicator "T1", "T2", "T3", and "T4" shows on display.
2. Press the HOUR button to advance hour digit.
3. Press the MINUTE button to advance minute digit.
4. Press the SECOND button to advance second digit.
5. Press the HOUR, MINUTE or SECOND button for 2 seconds for fast setting of the corresponding digit.
6. Press the CLEAR button to clear the Count-Down Timer and the corresponding timer memory to 00H00M00S
7. Press the HOUR and the CLEAR buttons simultaneously to clear the hour digit setting only.
8. Press the MINUTE and the CLEAR buttons simultaneously to clear the minute digit setting only.
9. Press the SECOND and the CLEAR buttons simultaneously to clear the second digit setting only.

Count-Down Timer START/STOP

1. After time setting is ready, press the START/STOP button once. The timer will start to countdown at 1 second resolution.
2. Press the START/STOP button once to stop the counting timer.
3. Press the START/STOP button once again, the timer will resume counting.

Count-Down Timer Alarm

1. When the timer counts down to 0:00 00 in its timer mode, the buzzer will sound.
2. When the timer counts down to 0:00 00 but not in its timer mode, the buzzer will sound and the flashing frequency of corresponding indicator is relatively slower.
3. When two timers countdown to 0:00 00 at the same time, the timer which shows on display will sound and the other's indicator will flash relatively slower.
4. Press any button to stop timer alarm and the count-up timer.

Count-Down Memory Recall

1. Press the START/STOP button to recall previous timer setting. Press the START/STOP button again to start the timer.

Stop Watch Mode





1. In timer mode, clear timer by pressing the CLEAR button.
2. Press the START/STOP button to start the stop watch counting up at 1 second resolution.
3. Press the START/STOP button to stop counting up.
4. When timer counts up to 99H 59M 59S it starts to count up again from 00H 00M 00S.

Battery Replacement

Use a coin to open the battery cover at back side of timer, following the arrow direction. Remove exhausted battery and insert a new 1.5V G-13 size button cell battery (make sure positive '+' is facing up) and close battery cover.

Automation saves time and money!

ANKOM Technology is an international company with products that include...

	<p>FLEX Analyte Extractor</p> <ul style="list-style-type: none"> • Simplifies fat-soluble vitamin and cholesterol analysis • Crude and total fat analysis capability coming soon • Eliminates chemical handling to improve safety • Eliminates bi-phase extractions • Provides ability to create custom methods
	<p>TDF Dietary Fiber Analyzer</p> <ul style="list-style-type: none"> • Automates AOAC 991.43, 985.29, 2009.01, and 2011.25 (and associated AACC methods) • IDF/SDF and TDF values • Faster, Technician-free Filtering • Computer controlled operation • Reduced per assay costs
	<p>DELTA Automated Fiber Analyzer with Pump System</p> <ul style="list-style-type: none"> • Crude Fiber (AOCS Ba 6a-05), ADF, NDF determinations • Automatically adds solutions and rinses • Batch process - up to 24 samples at one time
	<p>XT15 Fat Extractor</p> <ul style="list-style-type: none"> • Official Method AOCS Am 5-04 • Fully automatic • Solvent recovery at 97% or greater • Batch process - up to 15 samples at one time
	<p>RF Gas Production System</p> <ul style="list-style-type: none"> • High sensitivity pressure measurement • Anaerobic activity analyses (rumen, yeast, beer/wine fermentation, biomass, biodegradability, etc.) • Soil respiration • Wireless Computer control and data storage

Please visit our web site at www.ankom.com for more information.

2052 O'Neil Rd, Macedon NY 14502
 Telephone: (315) 986-8090
 Fax: (315) 986-8091
www.ankom.com

